

Frezen

Specialist in
verspanende
gereedschappen



Welkom in de vernieuwde RvS Tools Frezencatalogus

RvS Tools heeft de catalogus compleet vernieuwd en voor u een handig systeem met iconen aangebracht. **Veel freesplezier namens het team van RvS Tools!**

Werk veilig! Zie de veiligheidsvoorschriften op pagina 4.

I – Iconen

Naast de frees vindt u iconen:

- I Vorm
- II Messen/Snijmateriaal
- III Geleiding



Voorbeelden

Vormen: Er zijn vier basisvormen en combinaties daarvan.

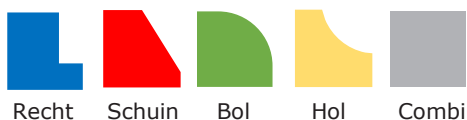

Recht Schuin Bol Hol Combi

Geleiding:

Een kogellager (of 'wielkje')
of een aanlooptap
of een kopieerring in de freesmachine



Messen:

Vaste messen (gesoldeerd)

Materiaal:

- HM — Hardmetaal
- VHM — Vol hardmetaal
- HSS
- HSS-e
- Diamant



HM Wisselmessen:
bij intensief gebruik
(geschroefd of geklemd)



II – Basisinfo

As/Schacht

Minimale inspanhoogte: 25mm

Diameters

Metrisch: 6, 8, 10 en 12mm

Inches: 1/4" en 1/2"

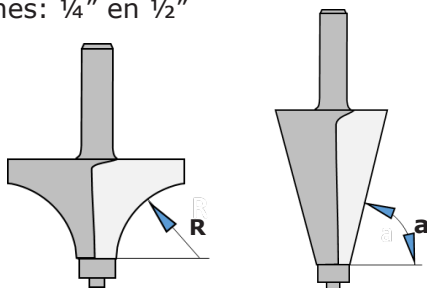

Maten (dimensies)

De belangrijkste:

- d - as of schachtmaat
- D - diameter - freesdeel
- L - lengte - totale lengte
- B - snijhoogte
- a - snijhoek
- R - radius
- T - snijdiepte

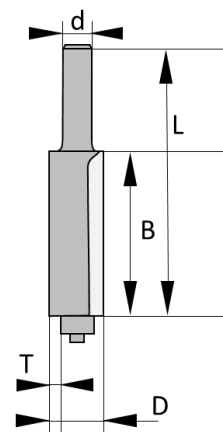

III – Extra info

U = Uitlopend

P = Parts/Onderdelen

Binnenkort kunt u een uitgebreide toelichting en praktische frees-instructies vinden in het RvS Tools Frezen Werkboek!

Frezen

Hardmetalen Frezen

Praktische wenken en veiligheidsvoorschriften voor het gebruik van frezen in de bovenfreesmachine:

Monteren

- Tijdens het monteren van de frees in de machine dient de stekker uit de contactdoos te zijn;
- As van de frees zo ver mogelijk in de spantang steken;
- Een frees die te ver uit de spantang steekt loopt onnodig veel risico op breuk en krom slaan van de as door bijvoorbeeld een knoest in hout

Freesdiepte

- Grotere freesdiepte kunt u bereiken door de freesmachine op diepte in te stellen, **niet** door de frees verder uit de spantang te laten steken!
- Dieper uitfrezen en grotere verspaningen in het werk dient in meerdere bewerkingen trapsgewijs uitgevoerd te worden

Veiligheid

- Als u uit de hand freest, dient u het te frezen materiaal goed vast te klemmen;
- Het dragen van een veiligheidsbril is aan te bevelen;
- Tijdens het werken met de freesmachine dient u loshangende kledingstukken (bijvoorbeeld een sjaal of stropdas) te vermijden;
- Houd rekening met het maximum toerental van de frees! Indien er niets vermeld wordt op de frees of de verpakking is het **maximum toerental 24.000** omwentelingen per minuut

Disclaimer: Afgebeelde onderdelen maken niet altijd onderdeel uit van de standaard levering

Winkelpresentatie

Er zijn verschillende presentatiemogelijkheden voor de frezen. Op dit moment is de verpakte frees van de toplijn RvS/Dimar zeer in trek. Bij de Amaxx frezenlijn is het perspex frezenkastje het meest populair.

Frezen Displaywand

Onze frezen presentatiemogelijkheden zorgen ervoor dat het gehele frezenassortiment goed zichtbaar is voor de klant: in één oogopslag het juiste freesresultaat gevonden en aan de slag! Ook voor het verkooppunt zijn er tal van voordelen aan de displaymogelijkheden: het inruimen wordt sterk vereenvoudigd, bestellen met barcode en/of bestelnummer is mogelijk en zelfs met een lege pin is het freesresultaat nog zichtbaar.

Specificaties:

- Assortiment ca. 120 frezen
- Afmeting: 130x100cm
- Frezen in luxe doosjes verpakt
- Stevige kartonnen verpakking voorzien van bestelnummer, barcode, freesresultaat en dimensies
- Pin met 1 tot 3 doosjes
- Bestelkaart met barcode, bestelnummer en freesresultaat

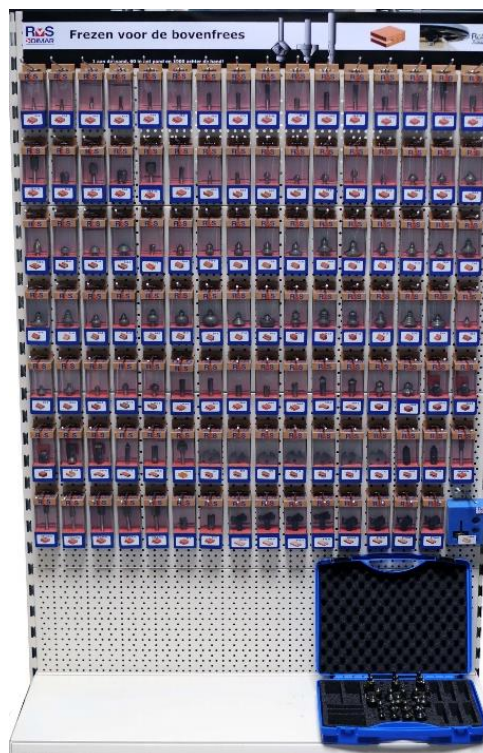

Amaxx Frezenkast

Een compacte oplossing voor de presentatie van onze Amaxx lijn. Bestelnummers staan naast de frees voor eenvoudig nabestellen. Tevens voorzien van een slot.

Optioneel kunnen Amaxx frezen ook verpakt geleverd worden.

Specificaties:

- Assortiment ca. 40 verschillende frezen
- Afmeting: 47x31x21cm (h*b*d)
- Iedere frees heeft zijn eigen positie op een plank met artikelnummer
- Voor zowel 6mm als 8mm frezen



Informeer naar de mogelijkheden, wij helpen u graag de juiste frezenpresentatie voor uw verkooppunt te ontdekken!

Frezen

Groeffrezen	11
Schijffrezen	19
Afschuinen en Kanten	21
Randen Bewerken	31
Profielgroeven en Graveren	33
Handgrepen	38
Bossingpanelen	39
Paneeldeuren	42
Verbindingen Frezen	44
Profileren	46
Corian Frezen	50
Speciale toepassingen	52
Amaxx Frezen vaste messen	54
Amaxx wisselmesfrezen	57
Overige HSS frezen	59
Frezensets	62
Boren voor de Bovenfrees	66
Onderdelen en toebehoren	67
Index Frezencatalogus	74

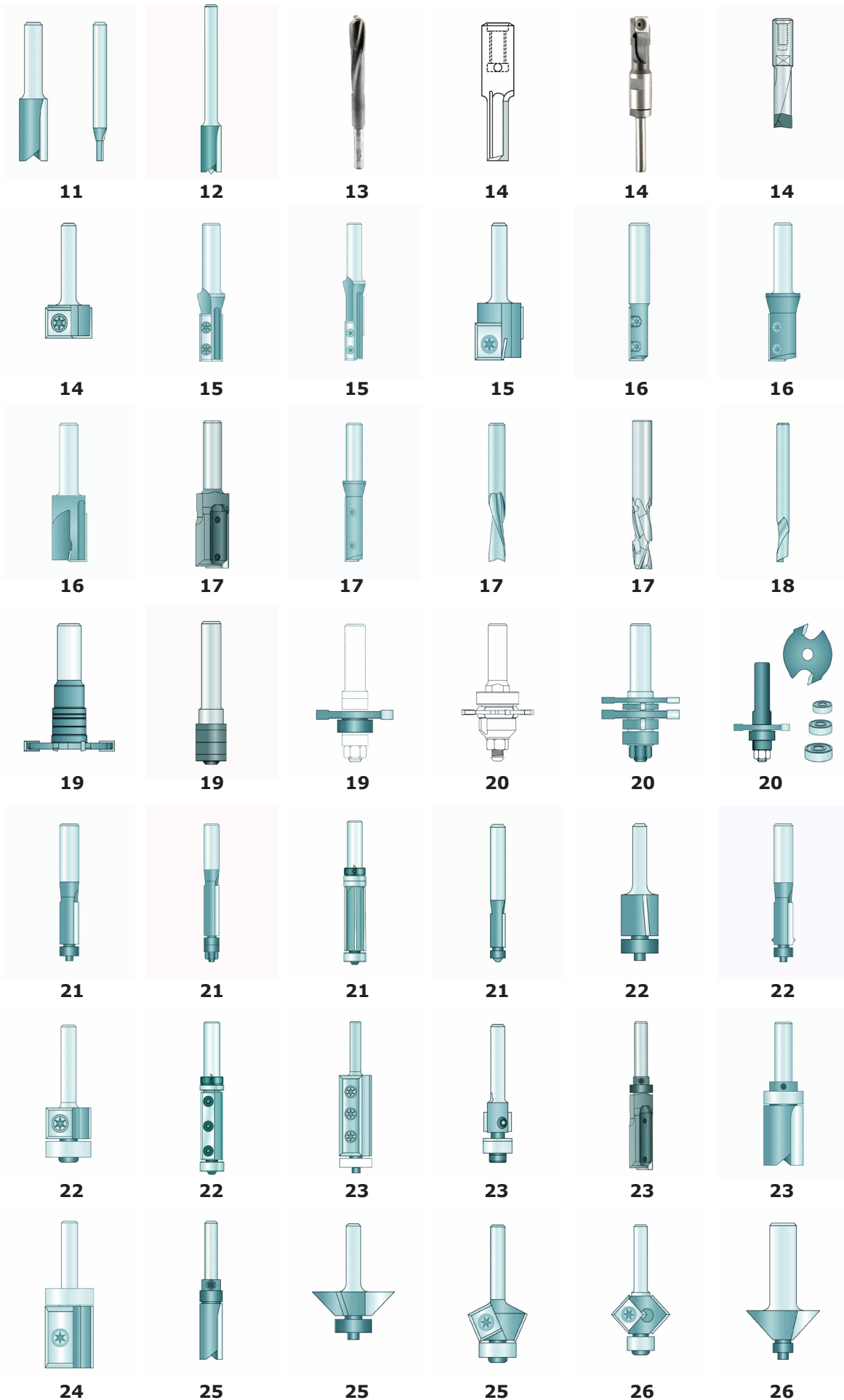

Frezen

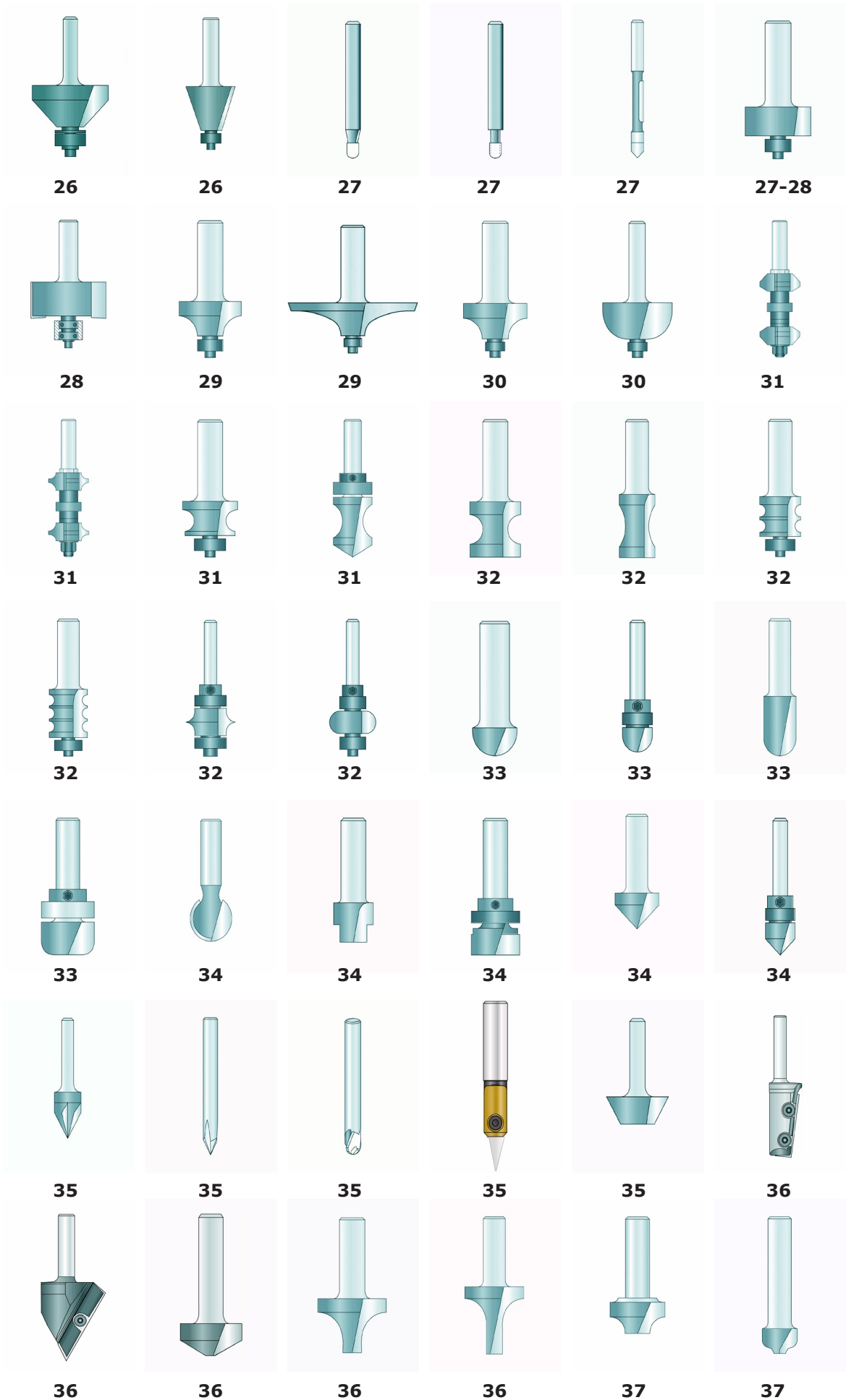

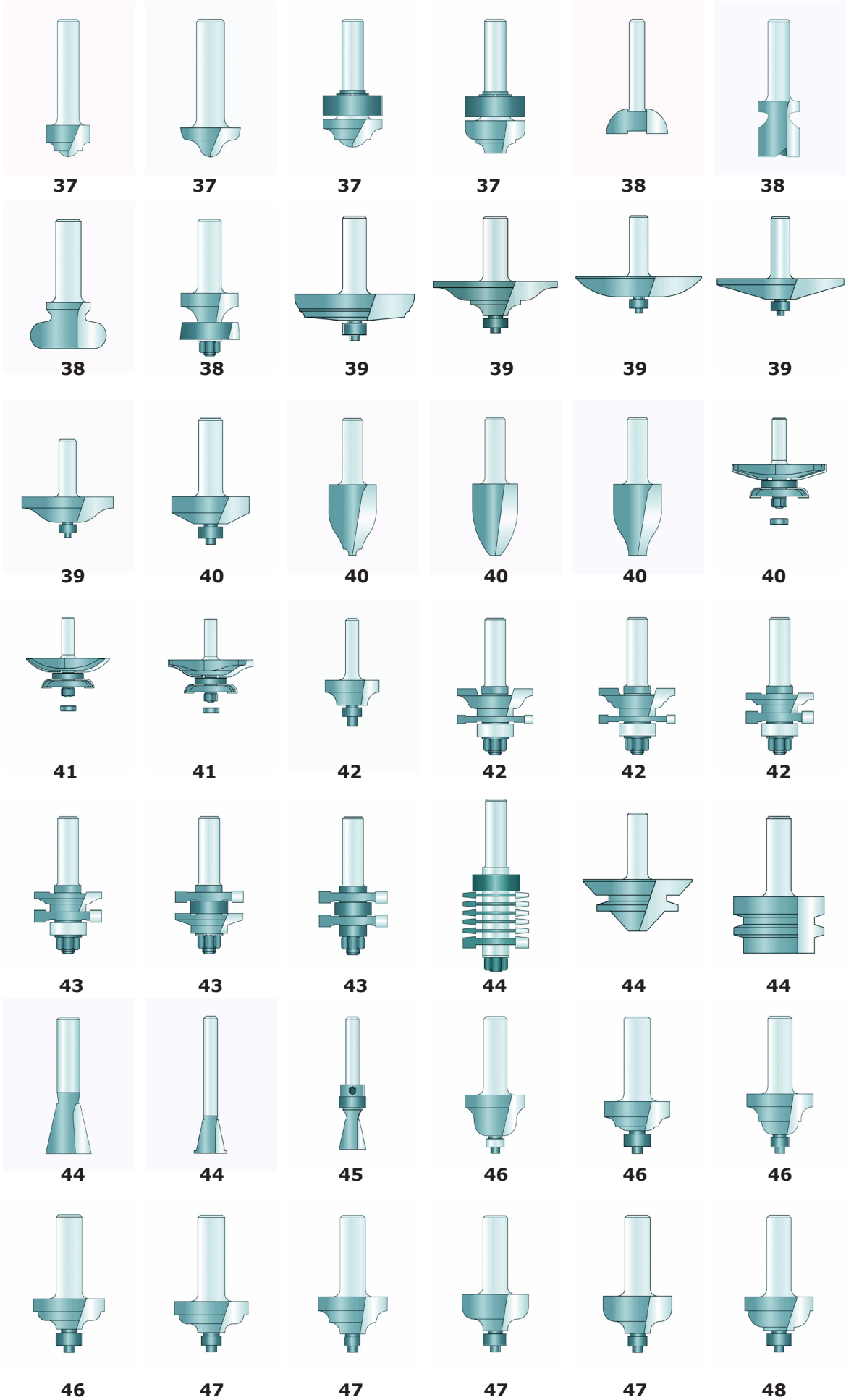

Frezen

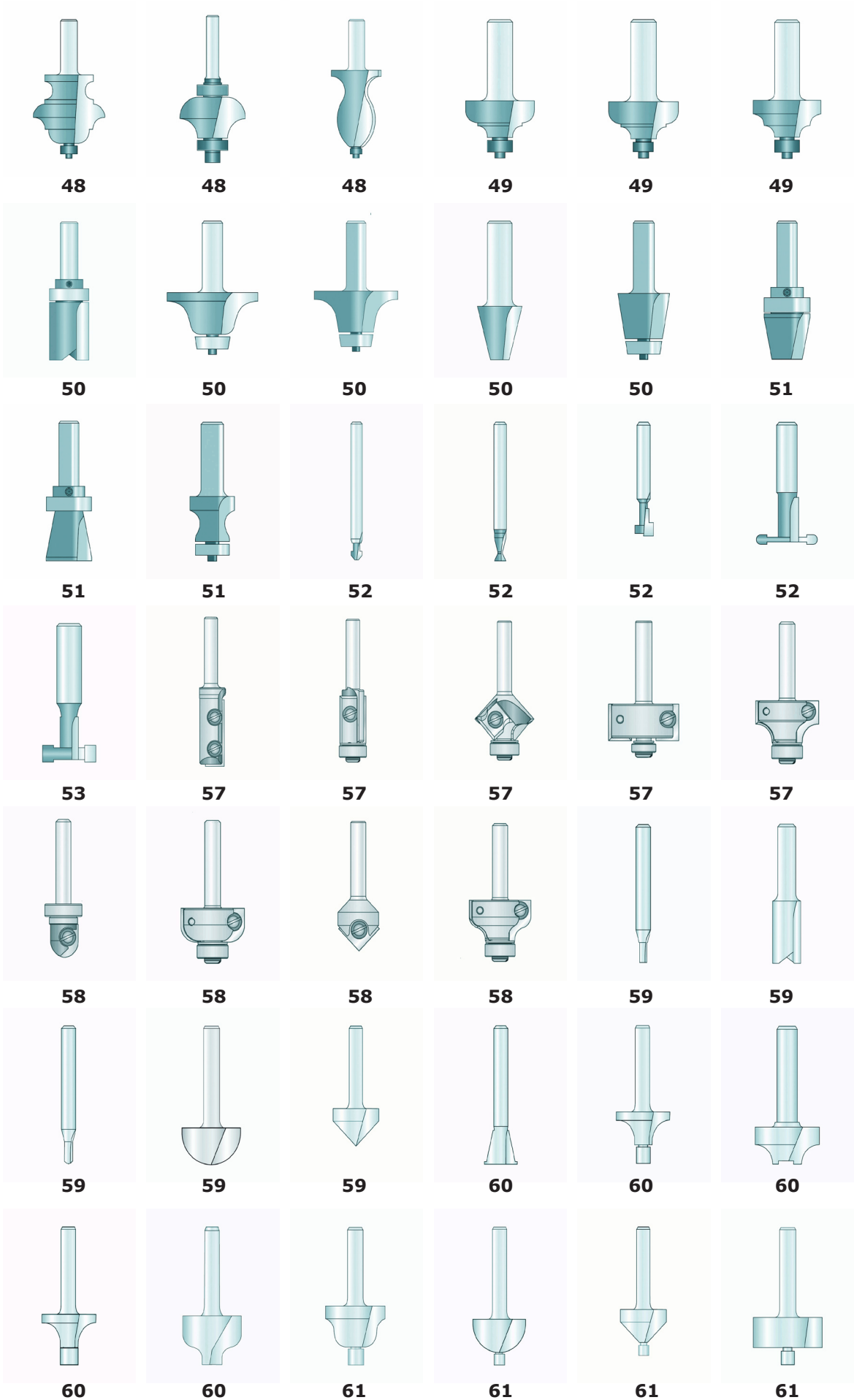

Groeffrezen

Vol HM Groeffrees Dnamic

Groeffrezen met Dnamic vol HM; Inborend

Toepassing: Langere standtijd speciaal voor materialen als MDF

Uitvoering: Z=2; d=6 mm

Bestelnr.	D	B	L	d	P	U
37-6	2	6,5	47	6		
38-6	2,5	8	48	6		
40-6	3	11	51	6		
41-6	4	11	51	6		
41-6-XL	4	11	70	6		
42-6	5	11	51	6		
42-6-L	5	16	56	6		

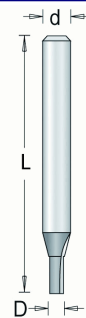
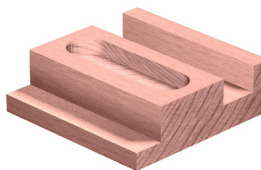

HM Groeffrees Dnamic

Groeffrezen met Dnamic HM; Ondersnijdend

Toepassing: Langere standtijd speciaal voor materialen als MDF

Uitvoering: Z=2; d=6 mm

Bestelnr.	D	B	L	d	P	U
43-6	6	19	51	6		
44-6	6	25	57	6		
45-6	7	19	51	6		
46-6	8	19	51	6		
47-6	8	25	57	6		
59-6	9	19	51	6		
48-6	10	19	51	6		
49-6	10	32	64	6		
143-6	11	25	57	6		
50-6	12	19	51	6		
51-6	12	32	64	6		
144-6	13	19	51	6		
52-6	14	19	51	6		
58-6	15	19	51	6		
53-6	16	25	57	6		
54-6	18	19	51	6		
55-6	20	19	51	6		
56-6	22	19	51	6		
57-6	25	19	51	6		

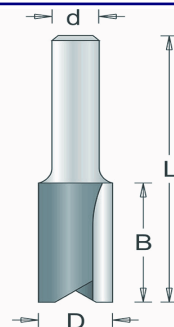
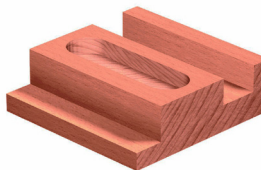

HM Groeffrees Dnamic

Groeffrezen met Dnamic HM; Ondersnijdend

Toepassing: Langere standtijd speciaal voor materialen als MDF

Uitvoering: Z=2; d=6,35 mm

Bestelnr.	D	B	L	d	P	U
46-635	8	19	57	6,35		U
48-635	10	19	51	6,35		U
50-635	12	19	51	6,35		U
52-635	14	19	51	6,35		U
53-635	16	25	57	6,35		U

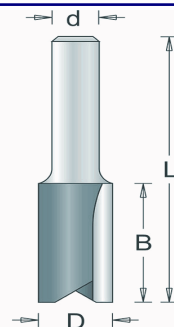

Vol HM Groeffrees Dnamic d=8mm

Groeffrezen met Dnamic vol HM; Inborend

Toepassing: Langere standtijd speciaal voor materialen als MDF

Uitvoering: Z=2; d=8 mm

Bestelnr.	D	B	L	d	P	U
37-8	2	6	45	8		
38-8	2,5	8	51	8		
40-8	3	11	51	8		
41-8	4	11	51	8		
42-8	5	11	51	8		
42-8-L	5	16	56	8		
43-8	6	19	57	8		

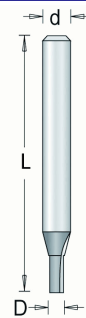
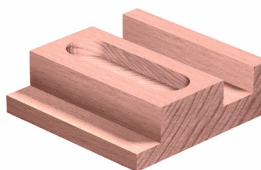

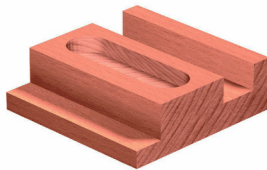
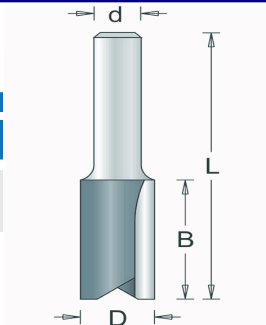

HM Groeffrees Dnamic d=8mm

Groeffrezen met Dnamic HM; Ondersnijdend

Toepassing: Langere standtijd speciaal voor materialen als MDF

Uitvoering: Z=2; d=8 mm

Bestelnr.	D	B	L	d	P	U
44-8	6	25	63	8		
45-8	7	19	57	8		
46-8	8	19	57	8		
47-8	8	25	63	8		
47-8-XL	8	25	80	8		
59-8	9	19	51	8		
48-8	10	19	51	8		
48-8-L	10	25	57	8		
49-8	10	32	64	8		
49-8-XL	10	32	80	8		
143-8	11	25	57	8		
50-8	12	19	51	8		
50-8-L	12	25	57	8		
51-8	12	32	64	8		
51-8-XL	12	32	90	8		
144-8	13	19	51	8		
52-8	14	19	51	8		
52-8-L	14	25	57	8		
52-8-XL	14	19	70	8		
58-8	15	19	51	8		
58-8-L	15	25	57	8		
58-8-XL	15	19	80	8		
153-8	16	19	51	8		
53-8	16	25	57	8		
53-8-XL	16	25	85	8		
54-8	18	19	51	8		
54-8-XL	18	19	70	8		
130-8	19	19	51	8		
55-8	20	19	51	8		
55-8-XL	20	19	70	8		
56-8	22	19	51	8		
56-8-XL	22	19	70	8		
149-8	24	19	51	8		
57-8	25	19	51	8		
57-8-XL	25	19	80	8		

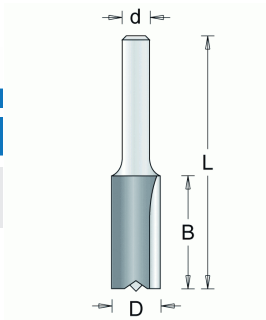

HM Groeffrees Inborend

Ondersnijdend en inborend

Uitvoering: Z=2; Met HM boorpunt

Bestelnr.	D	B	L	d	P	U
346-6	8	19	63	6		
348-6	10	19	63	6		
350-6	12	19	51	6		
352-6	14	19	61	6		
353-6	16	25	67	6		
354-6	18	19	51	6		
355-6	20	19	51	6		
346-8	8	19	63	8		
348-8	10	19	63	8		
350-8	12	19	51	8		
351-8	12	32	63	8		
352-8	14	20	60	8		
353-8	16	25	67	8		
354-8	18	19	51	8		
355-8	20	19	51	8		
3212-12	12	32	63	12		
3216-12	16	32	73	12		
3220-12	20	25	67	12		

HM Slotkastgroeffrees XXL Inborend

Inborend

Toepassing: Frezen voor het maken van slotkasten

Uitvoering: Z=2; Met HM boorpunt

Bestelnr.	D	B	L	d	P	U
348-8XXL	10	30	97	8		
351-8XXL	12	30	97	8		
352-8XXL	14	30	97	8		
353-8XXL	16	30	97	8		
354-8XXL	18	30	97	8		
355-8XXL	20	30	97	8		

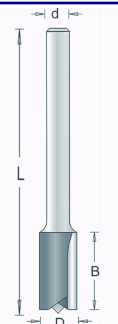
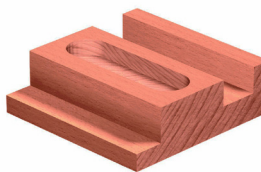

HM

HM Slotkastgroeffrees XXL CNC

Inborend; Met name geschikt voor CNC bewerkingen

Toepassing: Frezen voor het maken van slotkasten

Uitvoering: Z=2

Bestelnr.	D	B	L	d	P	U
471-12	12,7	25	151	12		
472-12	18	25	170	12		

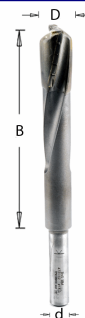

HM

HM Groeffrees d=10mm

Ondersnijdend

Uitvoering: Z=2; d=10 mm

Bestelnr.	D	B	L	d	P	U
210-10	10	32	76	10		U
212-10	12	32	73	10		U
212-10-XL	12	51	92	10		U
214-10	14	32	73	10		U
216-10	16	32	73	10		U
216-10-L	16	40	73	10		U
216-10-XL	16	50	96	10		U
218-10	18	32	68	10		U
218-10-XL	18	38	73	10		U
220-10	20	32	73	10		U
222-10	22	32	73	10		U
225-10	25	32	73	10		U

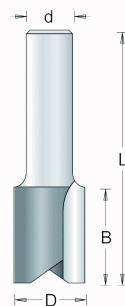

HM

HM Groeffrees d=12mm

Ondersnijdend

Uitvoering: Z=2; d=12 mm

Bestelnr.	D	B	L	d	P	U
208-12	8	19	63	12		
210-12	10	32	76	12		
212-12	12	32	73	12		
212-12-XL	12	51	108	12		
214-12	14	32	73	12		
216-12	16	32	73	12		
216-12-XL	16	50	96	12		
218-12	18	32	73	12		
218-12-XL	18	51	92	12		
220-12	20	32	73	12		
220-12-XL	20	50	89	12		
222-12	22	32	73	12		
225-12	25	32	73	12		
230-12	30	25	66	12		
235-12	35	25	66	12		
240-12	40	25	66	12		

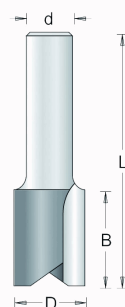

HM

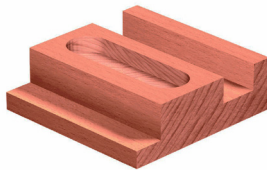
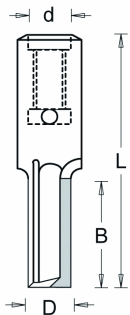

HM Groeffrees M10

Ondersnijdend

Uitvoering: Z=2; Binnendraad d=M10x1,5

Bestelnr.	D	B	L	d	P	U
1010N	10	32	66	M10		
1012N	12	35	70	M10		
1014N	14	35	70	M10		
1016N	16	45	75	M10		
1018N	18	45	75	M10		
1020N	20	45	75	M10		
1022N	22	38	68	M10		
1024N	24	38	77	M10		
1025N	25	32	61	M10		
1030N	30	25	50	M10		

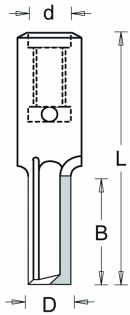

HM Groeffrees M12

Ondersnijdend

Uitvoering: Z=2; Binnendraad d=M12x1

Bestelnr.	D	B	L	d	P	U
1210M	10	32	66	M12		
1212M	12	32	66	M12		
1214M	14	32	66	M12		
1216M	16	38	70	M12		
1218M	18	38	68	M12		
1220M	20	35	67	M12		
1222M	22	35	67	M12		
1225M	25	32	62	M12		
1230M	30	25	54	M12		
1234M	34	25	53	M12		
1235M	35	25	53	M12		



HM Wisselmes Groeffrees M12x1

Inborend; Afbeelding in combinatie met verloop 554

Uitvoering: Z=2; Binnendraad d=M12x1

Bestelnr.	D	B	L	d	P	U
1218WM	18	20	65	M12		

Toebehoren:

Bestelnr.	Omschrijving	is voor:
LV12	Mes 12x12x1,5/4sn	
SC3950	Boutje Torx M4x6	
SLT15	Torx sleutel T15	

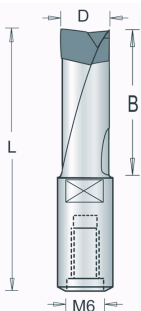

HM Groeffrezen M6

Toepassing: Voor Domino systeem

Uitvoering: Z=2; Binnendraad M6

Bestelnr.	D	B	L	d	P	U
321M6	5	20	49	M6		
322M6	6	28	49	M6		
323M6	8	28	49	M6		
324M6	10	28	49	M6		

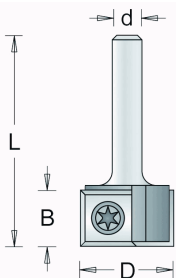

HM Groeffrees met wisselmessen 12mm

Ondersnijdend en niet inborend

Toepassing: Wordt geleverd met wisselmes en speciale sleutel

Uitvoering: Z=2; Snijhoogte 12mm

Bestelnr.	D	B	L	d	P	U
411-6	20	12	44	6		
412-6	22	12	44	6		
410-8	18	12	44	8		
411-8	20	12	44	8		

Toebehoren:

Bestelnr.	Omschrijving	is voor:
LV12	Mes 12x12x1,5/4sn	
SC1482	Boutje Torx M4x5,6	
SLT15	Torx sleutel T15	

HM Groeffrees met wisselmessen 30mm

Ondersnijdend en niet inborend

Toepassing: Wordt geleverd met wisselmes en speciale sleutel

Uitvoering: Z=2; Snijhoogte 30mm

Bestelnr.	D	B	L	d	P	U
432-8	16	30	72	8	A	
434-8	18	30	72	8	B	
436-8	20	30	72	8	B	
430-12	14	30	86	12	A	
432-12	16	30	88	12	A	
434-12	18	30	88	12	B	
436-12	20	30	88	12	B	
438-12	22	30	88	12	B	
440-12	25	30	88	12	B	

Toebehoren:

Bestelnr.	Omschrijving	is voor:
LV309	Mes 29,5x9x1,5/4sn	A
SC3548	Boutje Torx M3,5x4,8	A
LV3012	Mes 29,5x12x1,5/4sn	B
SC1482	Boutje Torx M4x5,6	B
SLT15	Torx sleutel T15	

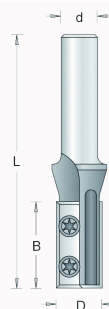

HM Groeffrees met wisselmessen 50mm

Ondersnijdend en niet inborend

Toepassing: Wordt geleverd met wisselmes en speciale sleutel

Uitvoering: Z=2; Snijhoogte 50mm

Bestelnr.	D	B	L	d	P	U
433-12	16	50	107	12	A	
435-12	18	50	107	12	B	
437-12	20	50	107	12	B	
439-12	22	50	107	12	B	

Toebehoren:

Bestelnr.	Omschrijving	is voor:
LV309	Mes 29,5x9x1,5/4sn	A
SC3548	Boutje Torx M3,5x4,8	A
LV3012	Mes 29,5x12x1,5/4sn	B
SC1482	Boutje Torx M4x5,6	B
SLT15	Torx sleutel T15	

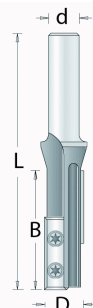

HM Groeffrees met wisselmessen Inborend

Ondersnijdend en inborend

Toepassing: Wordt geleverd met wisselmes en speciale sleutel

Uitvoering: Z=2; Snijhoogte 20mm

Bestelnr.	D	B	L	d	P	U
421-6	20	20	52	6		
422-6	22	20	52	6		
420-8	18	20	52	8		
421-8	20	20	52	8		
421-8-XL	20	20	72	8		
422-8	22	20	52	8		
420-12	18	20	60	12		
422-12	22	20	60	12		

Toebehoren:

Bestelnr.	Omschrijving	is voor:
LV12	Mes 12x12x1,5/4sn	
SC1482	Boutje Torx M4x5,6	
SLT15	Torx sleutel T15	

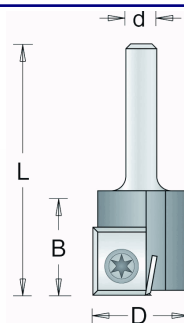
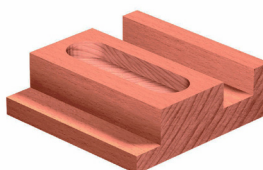

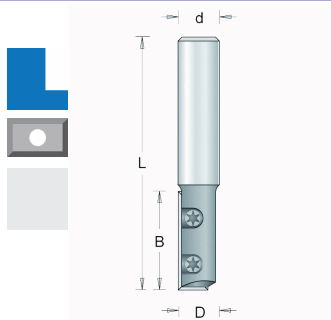

HM Groeffrees met wisselmessen Inborend

Ondersnijdend en inborend

Toepassing: Wordt geleverd met wisselmes en speciale sleutel

Uitvoering: Z=1; Snijhoogte 30mm

Bestelnr.	D	B	L	d	P	U
450-8	12	30	77	8		
450-8-XL	12	30	90	8		
450-8-XXL	12	30	107	8		
450-12	12	30	77	12		
450-12-XXL	12	30	107	12		
451-12	14	30	77	12		
452-12	15	30	77	12		

Toebehoren:

Bestelnr.	Omschrijving	is voor:
LV309	Mes 29,5x9x1,5/4sn	
SC3548	Boutje Torx M3,5x4,8	
SLT15	Torx sleutel T15	

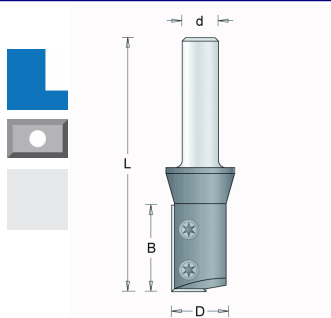

HM Groeffrees met wisselmessen Inborend

Ondersnijdend en inborend

Toepassing: Wordt geleverd met wisselmes en speciale sleutel

Uitvoering: Z=1; Snijhoogte 30mm

Bestelnr.	D	B	L	d	P	U
453-8	16	30	88	8		
453-12	16	30	88	12		
455-12	18	30	88	12		
457-12	20	30	88	12		
459-12	22	30	88	12		

Toebehoren:

Bestelnr.	Omschrijving	is voor:
LV3012	Mes 29,5x12x1,5/4sn	
SC3548	Boutje Torx M3,5x4,8	
SLT15	Torx sleutel T15	

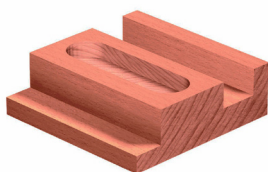
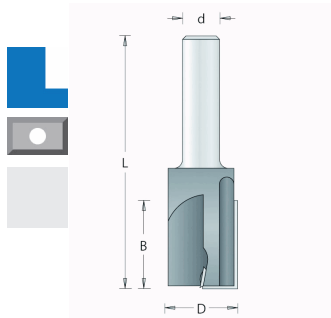

HM Groeffrees met wisselmessen Inborend

Ondersnijdend en inborend

Toepassing: Wordt geleverd met wisselmes en speciale sleutel

Uitvoering: Z=2; Snijhoogte 30mm

Bestelnr.	D	B	L	d	P	U
461-12	25	30	86	12		

Toebehoren:

Bestelnr.	Omschrijving	is voor:
L76	Mes 7,6x12x1,5/2sn	
SC3548	Boutje Torx M3,5x4,8	
LV3012	Mes 29,5x12x1,5/4sn	
SLT15	Torx sleutel T15	
SC1482	Boutje Torx M4x5,6	

HM Groeffrees met wisselmessen Lang

Ondersnijdend en inborend in lange uitvoering

Toepassing: Wordt geleverd met wisselmes en speciale sleutel

Uitvoering: Z=1; Snijhoogte 30mm; Extra ondermes

Bestelnr.	D	B	L	d	P	U
337-8	10	20	68	8	F	
338-8	12	30	78	8	ABD	
339-8	14	30	78	8	ABE	
340-8	16	30	79	8	ACE	
441-8	18	30	77	8	ACE	
342-8	20	30	79	8	ACE	
442-12	24	30	77	12	ACE	

Toebehoren:

Bestelnr.	Omschrijving	is voor:
SLT9	Torx sleutel T9	A
LKF30	Mes 30x5,5x1,1/4sn/RG	A
L76	Mes 7,6x12x1,5/2sn	B
LV12	Mes 12x12x1,5/4sn	C
SC4040	Boutje Torx M3,5x6	C
SLT9	Torx sleutel T9	D
SLT15	Torx sleutel T15	E
SLT10	Torx sleutel T10	E
LKF20	Mes 20x5,5x1,1/4sn/RG	F

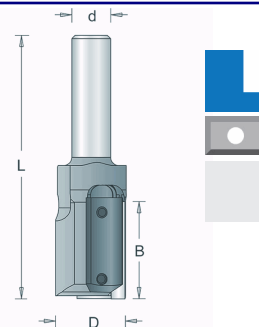

HM Groeffrees met wisselmessen Inborend

Ondersnijdend en inborend

Toepassing: Wordt geleverd met wisselmes en speciale sleutel

Uitvoering: Z=1; Snijhoogte 50mm

Bestelnr.	D	B	L	d	P	U
454-12	16	50	107	12		
456-12	18	50	107	12		
458-12	20	50	107	12		
460-12	22	50	107	12		

Toebehoren:

Bestelnr.	Omschrijving	is voor:
LV502	Mes 49,5x12x1,5/4sn	
SC3548	Boutje Torx M3,5x4,8	
SLT15	Torx sleutel T15	

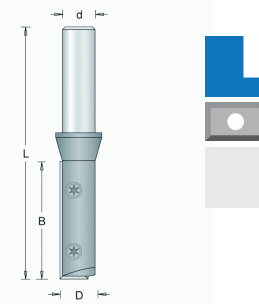

Vol HM Spiraalgroeffrees Dubbele groef

Vol HM met dubbele groef en ondersnijdend

Bestelnr.	D	B	L	d	P	U
S303-8	3	12	50	8		
S304-8	4	12	50	8		
S305-8	5	15	50	8		
S306-8	6	20	60	8		
S308-8	8	20	60	8		

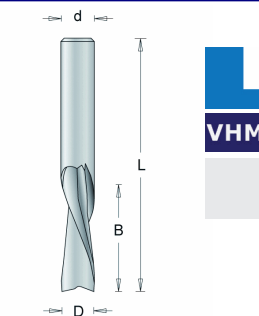
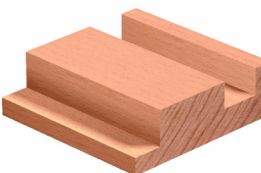

Vol HM Spiraalgroeffrees CNC

CNC Compressie

Bestelnr.	D	B	L	B1	d	P	U
701-8	8	20	70	5	8		
702-10	10	25	70	7	10		
703-12	12	32	80	9	12		

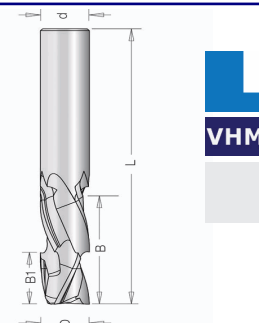
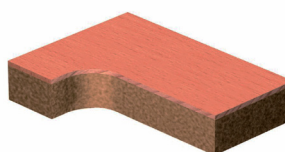

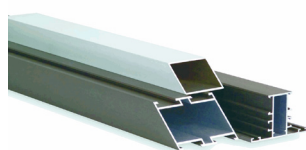
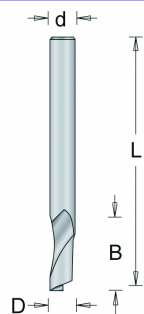

HSS-E groeffrees

Uitvoering: Voor aluminium en kunststof

Bestelnr.	D	B	L	d	P	U
60312	3	12	60	8		
60412	4	12	60	8		
60445	4	16/45	90	8		
60512	5	12	60	8		
60518	5	18/35	80	8		
61518	5	18	60	8		
60614	6	14	60	8		
60814	8	14	80	8		
61014	10	14	80	8		
61214	12	14	80	8		

Schijffrezen

HM Schijffrees verzonken 12mm

Wordt compleet geleverd

Uitvoering: Z=4; Met vlakke onderzijde

Bestelnr.	D	B	L	d	P	U
356-12	50	2	61	12		
357-12	50	3	61	12		
358-12	50	4	61	12		
359-12	50	5	61	12		
360-12	50	6	61	12		

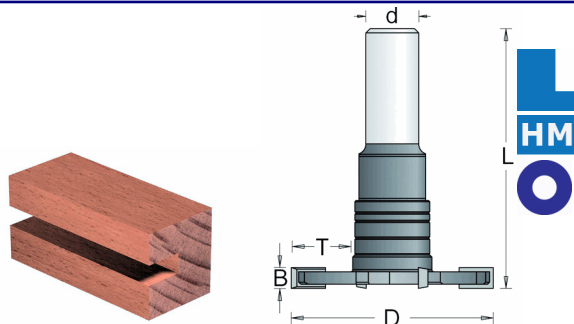

HM Schijffrees verzonken 8mm

Vlakke onderzijde, spindel wordt geleverd met ringen

Uitvoering: Z=3; Met verzonken kop

Bestelnr.	D	B	L	d	P	U
363	47,6	3		8		
364	47,6	4		8		
365	47,6	5		8		
366	47,6	6		8		
Spindel(s):						
361-8			59	8		

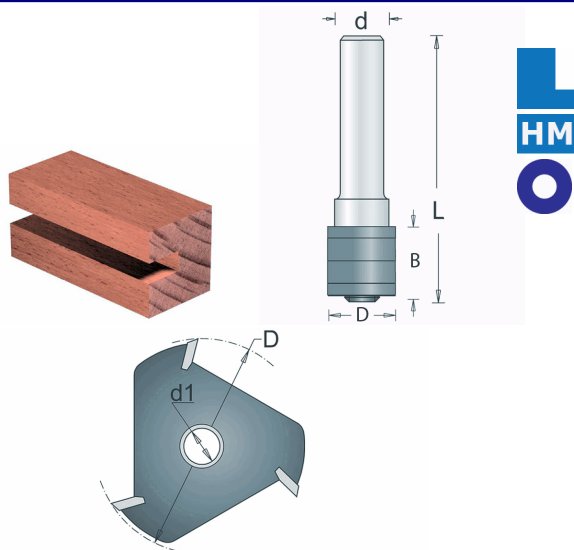

HM Schijffrees

Spindel voor 6 of 8 mm wordt afgeleverd met ringen te combineren met schijffrezen en lagers

Uitvoering: Z=2

Bestelnr.	D	B	L	d	P	U
250	40	1,5		6,35		
251	40	2		6,35		
252	40	2,5		6,35		
253	40	3		6,35		
254	40	4		6,35		
255	40	5		6,35		
256	40	6		6,35		
Spindel(s):						
257-6			55	6		
258-8			58	8		

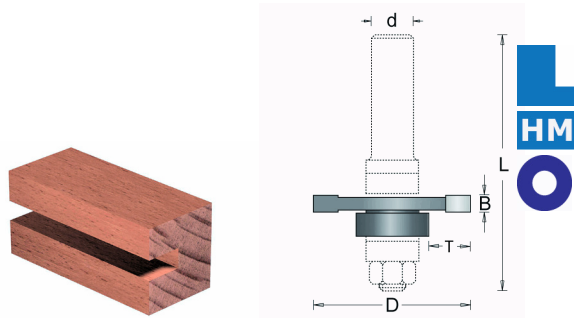

Toebehoren:

Bestelnr.	Omschrijving	is voor:
KL30	Lager 12,7x4,8x6,35	
KL50/259	Lager 16x5x6,35	
KL140/260	Lager 19x7x6,35	
RB170	Ring 12,7x3x6,35	
RB270	Ring 9,5x2,2x6,35	
RB50	Ring 12,7x5x6,35	

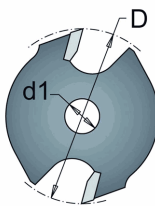

Kogellager	T [mm]
KL30	13,7
KL50/259	12
KL140/260	10,5

Frezen

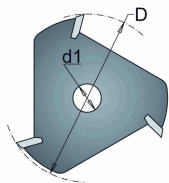
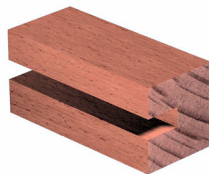
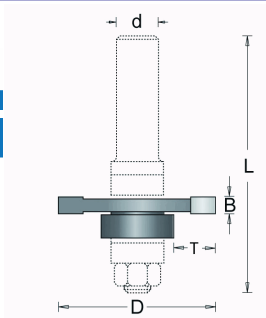

Kogellager	T [mm]
KL240	15,8
KL250	14,3
KL130/116	12,8

HM Schijffrees

Spindel voor 6, 8 of 12 mm wordt afgeleverd met ringen te combineren met schijffrezen en lagers

Uitvoering: Z=3

Bestelnr.	D	B	L	d	P	U
107	47,6	1,5		8		
108	47,6	2		8		
109	47,6	2,5		8		
110	47,6	3		8		
111	47,6	4		8		
112	47,6	5		8		
113	47,6	6		8		
Spindel(s):						
114-6			67	6		
115-8			70	8		
115-12			76	12		

Toebehoren:

Bestelnr.	Omschrijving	is voor:
KL240	Lager 16x5x8	
KL250	Lager 19x5x8	
KL130/116	Lager 22x7x8	
RB110	Vulring 16x1x8	
RB150	Vulring 16x3x8	
RB160	Vulring 16x6x8	

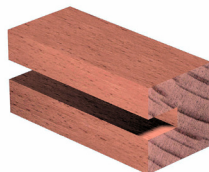
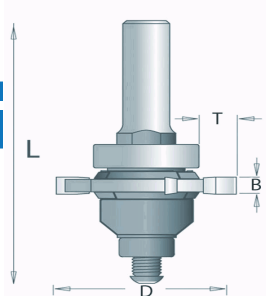

HM Traploos verstelbare groeffrees

Uitvoering: Z=4; In twee breedtes met schaalverdeling

Bestelnr.	D	B	L	T	d	P	U
401-8	50	3-5,5	79	10,7	8		
402-8	50	5,5-10	83	10,7	8		
401-12	50	3-5,5	85	10,7	12		
402-12	50	5,5-10	89	10,7	12		

Toebehoren:

Bestelnr.	Omschrijving	is voor:
KL180	Lager 28,6x7,9x12,7	

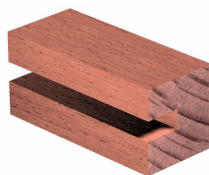
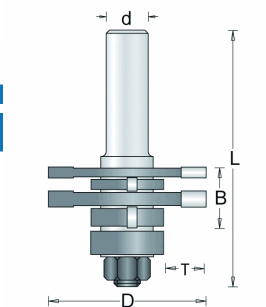

HM Quadri Pen/Groeffreeset

Toepassing: Compleet met 4 schijffrezen van B=3,2 - 4 - 4,8 en 6,3mm
Uitvoering: Voor groeven van 3,2 - 18mm

Bestelnr.	D	B	L	T	d	P	U
400-8	47,6	18	76	12,8	8		

Toebehoren:

Bestelnr.	Omschrijving	is voor:
KL130/116	Lager 22x7x8	
RB110	Vulring 16x1x8	
RB130	Vulring 16x0,5x8	
RB1000	Vulring 16x0,1x8	
RB160	Vulring 16x6x8	

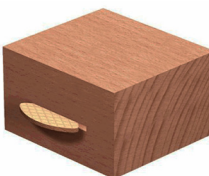
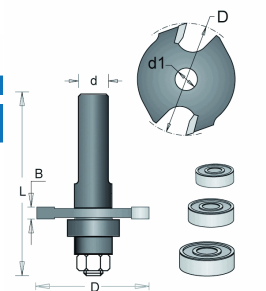

Lamelloset

Uitvoering: Met drie lagers

Bestelnr.	D	B	L	d1	d	P	U
221-8	40	4	60	6	8		

Toebehoren:

Bestelnr.	Omschrijving	is voor:
KLW15	Lager 15x6	
KL120	Lager 19x6x6	
KLW22	Lager 22x6	

Kogellager	T [mm]
KLW15	12,5
KL120	10,5
KLW22	9

Afschuinen en Kanten

HM Kantenfrees met onderlager

Uitvoering: Z=2; Met onderlager

Bestelnr.	D	B	L	d	P	U
103xs-3.2	4,8	11	51	3,2	A	
103xs-6	4,8	11	51	6	A	
103-6	12,7	25,4	63	6	B	
237-8	9,5	25,4	63	8	C	
103-8	12,7	25,4	63	8	B	

Toebehoren:

Bestelnr.	Omschrijving	is voor:
KLW48	Kogellager D=4.8	A
MRW48	Moertje D=4.8	A
RBW48	Ring lager	A
KL70	Lager 12,7x5x4,8	B
RB70	Ring lager 12,7x4,8	B
SC10	Boutje NC5-3/8	B
KL40	Lager 9,5x3,2x4,8	C
RB40	Ring lager 9,5x4,8	C
SR10	Ring boutje d=3,2	C

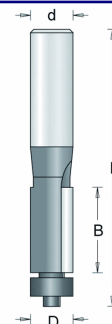
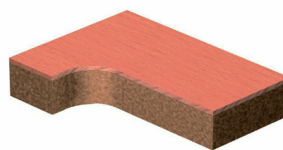

HM Kantenfrees met dubbel onderlager

Uitvoering: Z=2 (238-12) en Z=3 (239-12); Met dubbel onderlager

Bestelnr.	D	B	L	d	P	U
239-12	12,7	38,1	103	12		
238-12	12,7	51	117	12		

Toebehoren:

Bestelnr.	Omschrijving	is voor:
KL70	Lager 12,7x5x4,8	

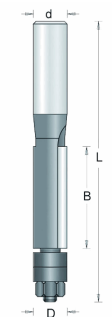
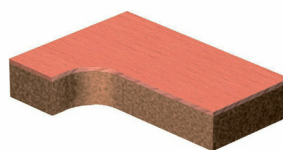

HM Kantenfrees met boven- en onderlager

Uitvoering: Z=4; Met boven- en onderlager

Bestelnr.	D	B	L	d	P	U
248-12	19,1	51	120	12		

Toebehoren:

Bestelnr.	Omschrijving	is voor:
KL200	Lager 19x4x12,7	KL1
KL140/260	Lager 19x7x6,35	KL2

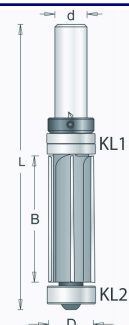
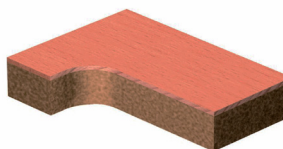

HM Kantenfrees met onderlager smal

Uitvoering: Z=2; Met onderlager smal

Bestelnr.	D	B	L	d	P	U
231-6	6,35	12,7	52	6		
233-6	6,35	25,4	65	6		

Toebehoren:

Bestelnr.	Omschrijving	is voor:
KL20	Lager 6,35x2,8x3,2	
SC20	Boutje Kruiskop NC2	

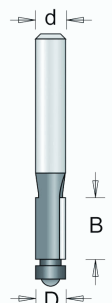
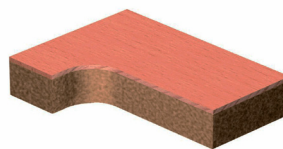

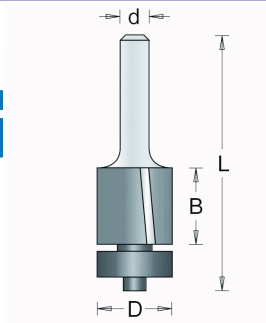

HM Kantenfrees Scherend met onderlager

Uitvoering: Z=2; Schuine snijhoek (scherend); Met onderlager

Bestelnr.	D	B	L	d	P	U
104-6	16	15,9	50	6	A	
189-6	19	16	61	6	B	
104-8	16	15,9	50	8	A	
189-8	19	16	64	8	B	

Toebehoren:

Bestelnr.	Omschrijving	is voor:
KL100	Lager 16x5x5	A
RB100	Ring lager 16x5	A
SR10	Ring boutje d=3,2	A
SC10	Boutje NC5-3/8	A
KL140/260	Lager 19x7x6,35	B
SR800	Ring boutje d=4,8	B
SC80	Boutje voor lager NF10	B

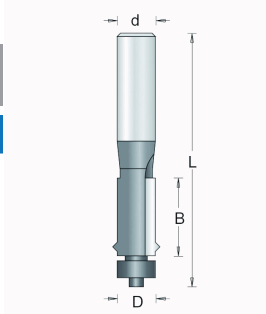

HM Kantenfrees met V-groef

Uitvoering: Z=2; Met onderlager

Bestelnr.	D	B	L	d	P	U
280-8	12,7	25,4	67	8		

Toebehoren:

Bestelnr.	Omschrijving	is voor:
KL70	Lager 12,7x5x4,8	

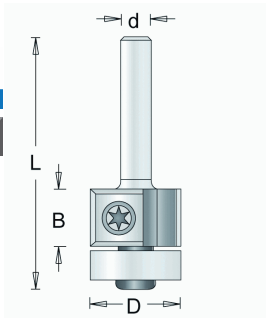

HM Kantenfrees met wisselmessen

Toepassing: Wordt geleverd met wisselmessen en speciale sleutel

Uitvoering: Z=2; Met onderlager

Bestelnr.	D	B	L	d	P	U
204-6	19	12	52	6	A	
404-6	19	30	70	6	B	
204-8	19	12	54	8	A	
403-8	19	20	60	8	C	
404-8	19	30	72	8	B	
404-12	19	30	78	12	B	

Toebehoren:

Bestelnr.	Omschrijving	is voor:
LV12	Mes 12x12x1,5/4sn	A
L30	Mes 30x12x1,5/2sn	B
SLT10	Torx sleutel T10	B
SC1482	Boutje Torx M4x5,6	AC
SLT15	Torx sleutel T15	AC
L20	Mes 20x12x1,5/2sn	C
KL120	Lager 19x6x6	

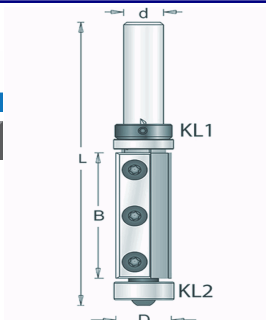

HM Kantenfrees met wisselmessen en lagers

Uitvoering: Z=4; Met wisselmessen en boven- en onderlager

Bestelnr.	D	B	L	d	P	U
213-12DL	19	50	100	12		

Toebehoren:

Bestelnr.	Omschrijving	is voor:
KL200	Lager 19x4x12,7	KL1
KL140/260	Lager 19x7x6,35	KL2
LV503	Mes 50x12x1,7/4sn/3G	
SC770	Boutje M4x12	
SC1482	Boutje Torx M4x5,6	
SLT15	Torx sleutel T15	
LR500	Borgring 18,2x6,35x5	

HM Kantenfrees met wisselmessen en onderlager XL

Uitvoering: Z=2; Met wisselmessen en onderlager extra lang

Bestelnr.	D	B	L	d	P	U
213-12	19	50	100	12		

Toebehoren:

Bestelnr.	Omschrijving	is voor:
KL140/260	Lager 19x7x6,35	
LV503	Mes 50x12x1,7/4sn/3G	
SC1482	Boutje Torx M4x5,6	
SLT15	Torx sleutel T15	

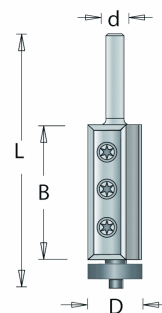
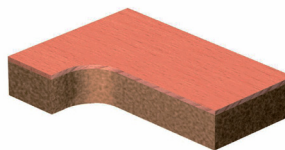

HM Kantenfrees met wisselmessen

Uitvoering: Z=2; Met onderlager

Bestelnr.	D	B	L	d	P	U
407-6	12,7	8,5	57	6		
407-8	12,7	8,5	57	8		

Toebehoren:

Bestelnr.	Omschrijving	is voor:
KL70	Lager 12,7x5x4,8	
L85	Mes 8,5x5,5x1,1/2sn	
SC330	Boutje M3	Lager
SC360	Stelboutje M3	Mes
SLT20	Torx sleutel T20	

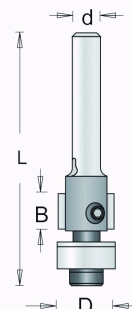

HM Kopieefrees met wisselmessen 6mm

Toepassing: Wordt geleverd met wisselmessen en speciale sleutel

Uitvoering: Z=2; Met bovenlager (aan de schacht)

Bestelnr.	D	B	L	d	P	U
445-6	12,7	30	80	6		

Toebehoren:

Bestelnr.	Omschrijving	is voor:
LV12	Mes 12x12x1,5/4sn	
LKF30	Mes 30x5,5x1,1/4sn/RG	
KL30	Lager 12,7x4,8x6,35	
LR110	Borgring 11x6,35x5	
SC4000	Boutje Torx M3x4	
SLT9	Torx sleutel T9	
SLT10	Torx sleutel T10	

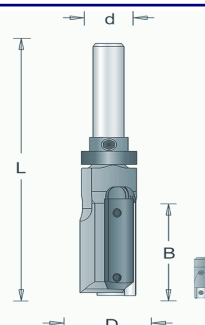

HM Kopieefrees met bovenlager 12mm

Uitvoering: Z=2; Met bovenlager groot

Bestelnr.	D	B	L	d	P	U
243-12	19,1	25,4	77	12	A	
241-12	19,1	50,8	92	12	A	
242-12	25,4	44,5	95	12	B	
375-12	28,6	38,1	92	12	C	

Toebehoren:

Bestelnr.	Omschrijving	is voor:
KL200	Lager 19x4x12,7	A
KL9210	Lager 25,4x6x12,7	B
LR500	Borgring 18,2x6,35x5	AB
KL180	Lager 28,6x7,9x12,7	C
LR200	Borgring 20x12,7x6	C

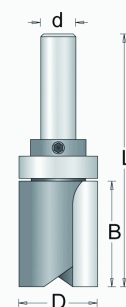
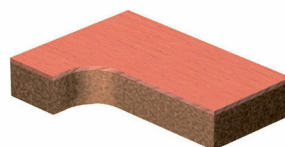

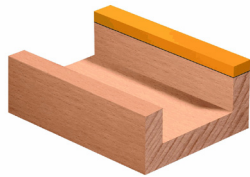
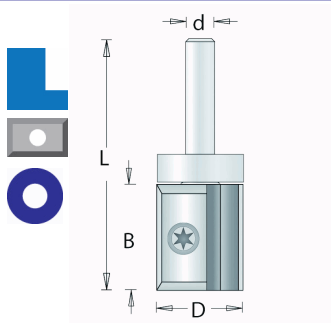

HM Kopieerfrees met wisselmessen 8mm

Toepassing: Wordt geleverd met wisselmessen en speciale sleutel
Uitvoering: Z=2; Met bovenlager (aan de schacht)

Bestelnr.	D	B	L	d	P	U
207-8	22	20	68	8		

Toebehoren:

Bestelnr.	Omschrijving	is voor:
SL50	Inbussleutel 1.55	
SC3950	Boutje Torx M4x6	
LR230	Borgring 16x8x5	
KL130/116	Lager 22x7x8	
LV20	Mes 19,5x12x1,5/4sn	

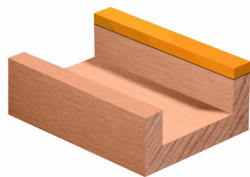
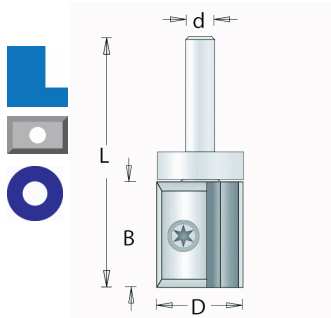

HM Kopieerfrees met wisselmessen 8mm

Toepassing: Wordt geleverd met wisselmessen en speciale sleutel
Uitvoering: Z=2; Met bovenlager (aan de schacht)

Bestelnr.	D	B	L	d	P	U
208-8	19	12	52	8	A	
209-8	19	20	60	8	B	
210-8	19	30	70	8	C	

Toebehoren:

Bestelnr.	Omschrijving	is voor:
LV12	Mes 12x12x1,5/4sn	A
LV20	Mes 19,5x12x1,5/4sn	B
KL250	Lager 19x5x8	ABC
LR230	Borgring 16x8x5	ABC
SC1480	Boutje Torx M4x5	AB
SL50	Inbussleutel 1.55	ABC
LV3012	Mes 29,5x12x1,5/4sn	C
SC1482	Boutje Torx M4x5,6	C
RB130	Vulring 16x0,5x8	C

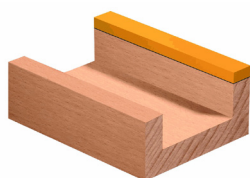
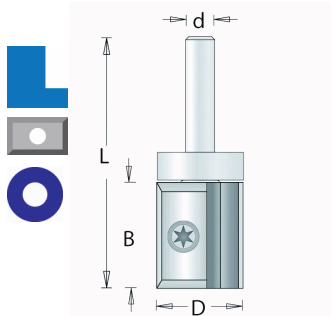

HM Kopieerfrees met wisselmessen 12mm

Toepassing: Wordt geleverd met wisselmessen en speciale sleutel
Uitvoering: Z=2; Met bovenlager (aan de schacht)

Bestelnr.	D	B	L	d	P	U
215-12	19	30	80	12	A	
211-12	19	50	100	12	B	

Toebehoren:

Bestelnr.	Omschrijving	is voor:
LV3012	Mes 29,5x12x1,5/4sn	A
LV503	Mes 50x12x1,7/4sn/3G	B
KL200	Lager 19x4x12,7	
LR500	Borgring 18,2x6,35x5	
SC211	Boutje NC5x2,5	
SC1482	Boutje Torx M4x5,6	
SL50	Inbussleutel 1.55	
SLT15	Torx sleutel T15	

HM Kopieerfrees met bovenlager 8mm

Uitvoering: Z=2; Met bovenlager

Bestelnr.	D	B	L	d	P	U
247-3.2	4,8	12	51	3,2	A	
247-6	4,8	12	51	6	A	
245xs-6	9,5	6	45	6	B	
245-6	12,7	25,4	63	6	C	
260-8	12	25	70	8	D	
249-8	16	32	73	8	E	

Toebehoren:

Bestelnr.	Omschrijving	is voor:
KLW48	Kogellager D=4.8	A
KLW95	Kogellager D=9.5	B
KL30	Lager 12,7x4,8x6,35	C
LR110	Borgring 11x6,35x5	C
KLW12	Kogellager 28x8 mm	D
KLW16	Lager 16x8	E

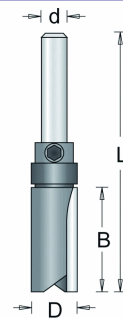
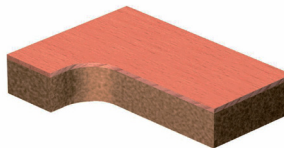

HM Kantenfrees 7°-45°

Uitvoering: Z= (A) en Z= (B); Met onderlager; a=7° - 45°

Bestelnr.	D	B	L	a	d	P	U
105xs-6	6,3	9,5	47	7	6	A	
106xs-6	14,3	6,3	47	45	6	A	
105-6	22,2	10	50	22	6	B	
106-6	30	10	50	45	6	B	
105-8	22,2	10	53	22	8	B	
106-8	30	10	53	45	8	B	

Toebehoren:

Bestelnr.	Omschrijving	is voor:
KLW48	Kogellager D=4.8	A
KLW5	Lager 15x6	B

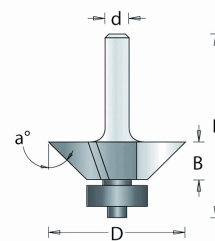
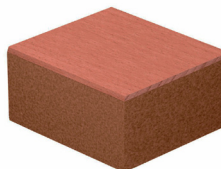

HM Kantenfrees met wisselmessen 15°-30°

Toepassing: Wordt geleverd met wisselmessen en speciale sleutel

Uitvoering: Z=2; Met onderlager; a= 15°- 30°

Bestelnr.	D	B	L	a	d	P	U
405-6	20	12	55	15	6		
205-6	24	12	55	25	6		
406-6	26	12	54	30	6		
405-8	20	12	55	15	8		
205-8	24	12	55	25	8		

Toebehoren:

Bestelnr.	Omschrijving	is voor:
LV12	Mes 12x12x1,5/4sn	
SC1482	Boutje Torx M4x5,6	
KL50/259	Lager 16x5x6,35	
SLT15	Torx sleutel T15	

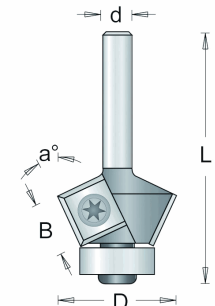
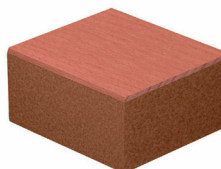

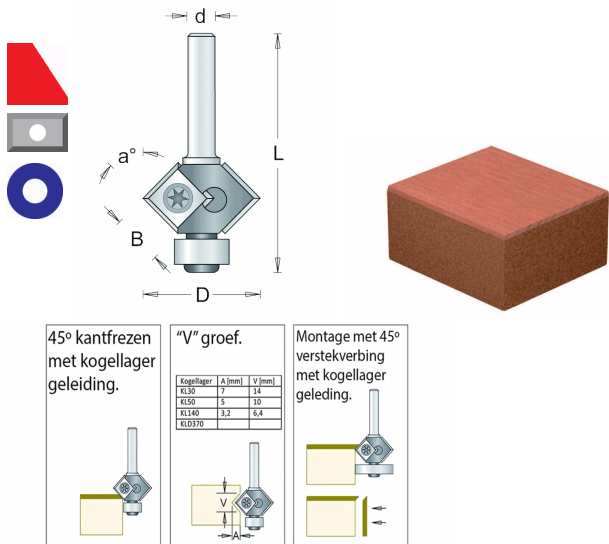

HM Kantenfrees met wisselmessen 45°

Toepassing: Wordt geleverd met wisselmessen en speciale sleutel
Uitvoering: Z=2; Met onderlager KL30; a= 45°

Bestelnr.	D	B	L	a	d	P	U
206-6	27	12	56	45	6		
206-8	27	12	58	45	8		

Toebehoren:

Bestelnr.	Omschrijving	is voor:
LV12	Mes 12x12x1,5/4sn	
SC1482	Boutje Torx M4x5,6	
KL30	Lager 12,7x4,8x6,35	
KL50/259	Lager 16x5x6,35	
KL140/260	Lager 19x7x6,35	
KLD370	Lager 27x5x6,35	
SLT15	Torx sleutel T15	

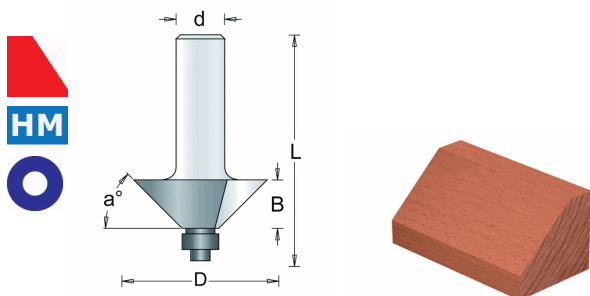

HM Hoekfrees 45°

Uitvoering: Met onderlager; a= 45°

Bestelnr.	D	B	L	a	d	P	U
87-6	31,8	12,7	50	45	6	A	
87-8	31,8	12,7	50	45	8	A	
187-12	60,5	25,4	74	45	12	B	

Toebehoren:

Bestelnr.	Omschrijving	is voor:
KL10	Lager 9,5x3,7x3,2	A
RB10	Ring lager 9,5x3,2	A
SC70	Boutje NC3-3/8	A
SR40	Ring boutje d=2,4	A
KL70	Lager 12,7x5x4,8	B
RB70	Ring lager 12,7x4,8	B
SC10	Boutje NC5-3/8	B
SR10	Ring boutje d=3,2	B

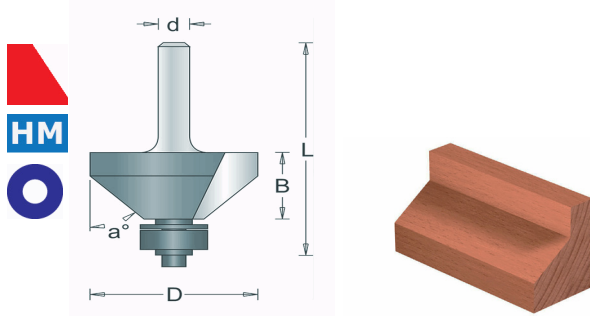

HM Fasefrees 45°

Uitvoering: Met onderlager; a= 45°

Bestelnr.	D	B	L	a	d	P	U
295-8	35	18	57	45	8		

Toebehoren:

Bestelnr.	Omschrijving	is voor:
KL70	Lager 12,7x5x4,8	
RB70	Ring lager 12,7x4,8	
SC10	Boutje NC5-3/8	
SR10	Ring boutje d=3,2	

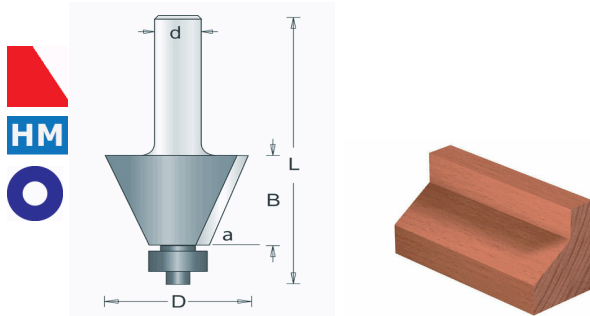

HM Fasefrees 15°

Uitvoering: Met onderlager; a= 15°

Bestelnr.	D	B	L	a	d	P	U
490-8	12,7	8,5	57	15	6		

Toebehoren:

Bestelnr.	Omschrijving	is voor:
KL70	Lager 12,7x5x4,8	
RB70	Ring lager 12,7x4,8	
SC10	Boutje NC5-3/8	
SR10	Ring boutje d=3,2	
SL10	Inbussleutel 2.4	

Vol HM Kantenfrees 7°

Uitvoering: a = 7°

Bestelnr.	D	B	L	a	d	P	U
154-6	4,76	6,35	38	7	6		
154-635	4,76	6,35	38	7	6,35		

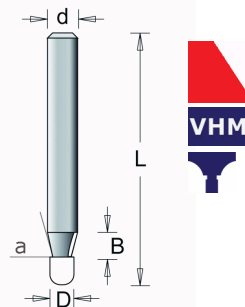

Vol HM Kantenfrees Recht

Uitvoering: Recht

Bestelnr.	D	B	L	d	P	U
152-6	6,35	6,35	38	6		
152-635	6,35	6,35	38	6,35		

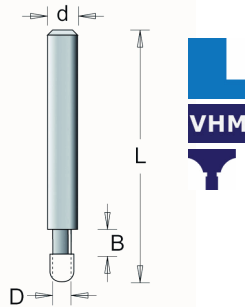
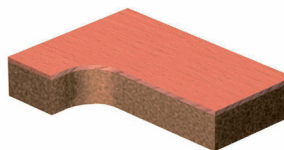

HM Inlaatfrees

Uitvoering: Z=1; Enkelvoudig snijdend met boorpunt en aanlooptap

Bestelnr.	D	B	L	d	P	U
39-6	6,3	19,1	64	6		
39-8	6,3	19,1	64	8		
39-12	12,7	30,1	89	12		

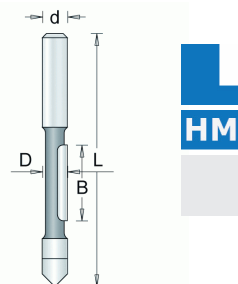
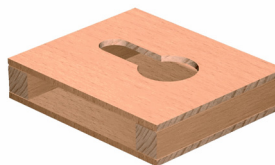

HM Spinningfrees

Uitvoering: Met onderlager KL70

Bestelnr.	D	B	L	d	P	U
88xs-6	11,1	13	47	6	A	
88-6	31,7	12,7	50	6	B	
88-8	31,7	12,7	50	8	B	

Toebehoren:

Bestelnr.	Omschrijving	is voor:
KLW48	Kogellager D=4,8	A
KL40	Lager 9,5x3,2x4,8	B
KL60	Lager 15,9x5x4,8	B
KL70	Lager 12,7x5x4,8	B
KL150	Lager 19x5x4,8	B

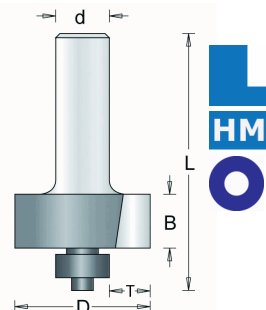
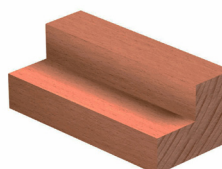

Kogellager	T [mm]
KLW48	3,2
KL40	11,1
KL60	9,5
KL70	7,9
KL150	6,4

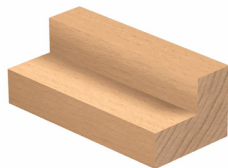
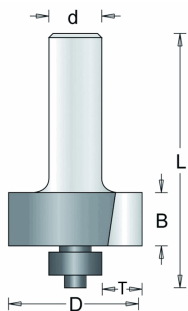

Kogellager	T [mm]
KL40	12,8
KL70	11,2
KL60	9,6
KL150	8

HM Spinningfrees Set

Uitvoering: Met 4 lagers

Bestelnr.	D	B	L	d	P	U
188-6	35	12,7	52	6		
188-8	35	12,7	54	8		
388-12	50,8	29,5	84	12		

Toebehoren:

Bestelnr.	Omschrijving	is voor:
KL40	Lager 9,5x3,2x4,8	
KL70	Lager 12,7x5x4,8	
KL60	Lager 15,9x5x4,8	
KL150	Lager 19x5x4,8	
RB70	Ring lager 12,7x4,8	
SC40	Boutje NC5-1/2	
SR10	Ring boutje d=3,2	

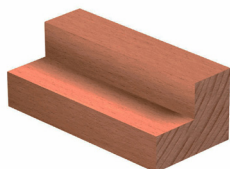
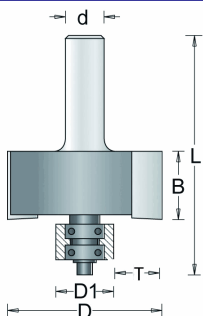

HM Spinningfrees met variabele breedte

Toepassing: Speciale Spinningfrees waarmee met diverse ringen (apart leverbaar) de gewenste slijpdiepte kan worden bereikt

Uitvoering: 1,2 - 19 mm breed

Bestelnr.	D	B	L	d	P	U
288-12	50,8	22,5	78	12		

Toebehoren:

Bestelnr.	Omschrijving	is voor:
RS910	D1=14.3 T=18.2	
RS800	D1=15.9 T=17.4	
RS810	D1=19 T=15.9	
RS920	D1=20.6 T=15.1	
RS820	D1=22.2 T=14.3	
RS830	D1=25.4 T=12.7	
RS930	D1=27 T=11.9	
RS840	D1=28.6 T=11.1	
RS850	D1=31.7 T=9.5	
RS940	D1=32.5 T=9.1	
RS860	D1=34.9 T=7.9	
RS870	D1=38.1 T=6.3	
RS950	D1=38.9 T=5.9	
RS880	D1=41.3 T=4.7	
RS890	D1=44.4 T=3.2	
RS900	D1=47.6 T=1.6	
KL30	Lager 12,7x4,8x6,35	
SR10	Ring boutje d=3,2	
RB270	Ring 9,5x2,2x6,35	
SC40	Boutje NC5-1/2	
SL10	Inbus sleutel 2.4	

HM Afrondfrees

Uitvoering: Met onderlager. Vanaf 280-12 en groter: Tmax 18.000-16.000

Bestelnr.	D	B	L	R	d	P	U
134xs-6	9,5	9,5	46	2,4	6	A	
135xs-6	11,1	9,5	46	3,2	6	A	
71xs-6	12,7	9,5	46	4	6	A	
134-6	15,9	7,9	46	1,6	6	B	
135-6	19,1	9,5	49	3,2	6	B	
135-635	19,1	9,5	49	3,2	6,35	B	
71-6	22,2	12,7	49	4,8	6	B	
72-6	25,4	12,7	49	6,3	6	B	
73-6	28,6	12,7	49	7,9	6	B	
74-6	31,8	15,9	52	9,5	6	B	
75-6	38,1	19,1	55	12,7	6	B	
134-8	15,9	7,9	46	1,6	8	B	
135-8	19,1	9,5	49	3,2	8	B	
71-8	22,2	12,7	49	4,8	8	B	
72-8	25,4	12,7	49	6,3	8	B	
73-8	28,6	12,7	49	7,9	8	B	
74-8	31,8	15,9	52	9,5	8	B	
75-8	38,1	19,1	55	12,7	8	B	
276-8	44,5	22,2	61	15,9	8	B	
276-12	44,5	22,2	61	15,9	12	B	
277-12	50,8	25,4	75	19,1	12	B	
278-12	57,1	29,4	79	22,2	12	B	
279-12	63,5	31,8	92	25,4	12	B	
Tmax18000							
280-12	69,9	34,9	95	28,6	12	B	
284-12	72,6	38,7	98	30	12	B	
281-12	76,3	38,1	98	31,8	12	B	
Tmax16000							
285-12	82,7	42	91	35	12	B	
282-12	88,9	44,5	105	38,1	12	B	

Toebehoren:

Bestelnr.	Omschrijving	is voor:
KLW48	Kogellager D=4,8	A
KL70	Lager 12,7x5x4,8	B
RB70	Ring lager 12,7x4,8	B
SC10	Boutje NC5-3/8	B
SR10	Ring boutje d=3,2	B

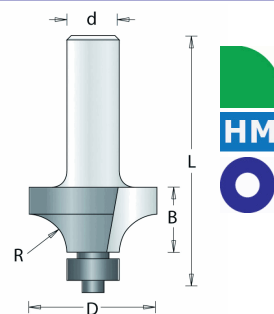
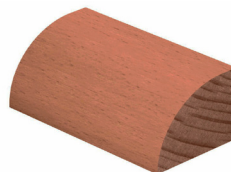

HM Afrondfrees/Kwartrondfrees Ovaal

Toepassing: Tmax: 18.000
Uitvoering: Met onderlager

Bestelnr.	D	B	L	R	d	P	U
283-12	69,2	16	76	43	12	A	
383-12	69,2	16	76	43	12	B	

Toebehoren:

Bestelnr.	Omschrijving	is voor:
KL70	Lager 12,7x5x4,8	A
KL40	Lager 9,5x3,2x4,8	B

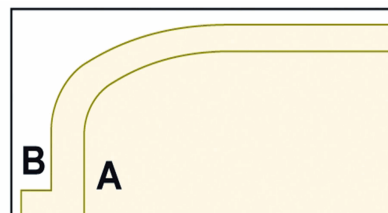
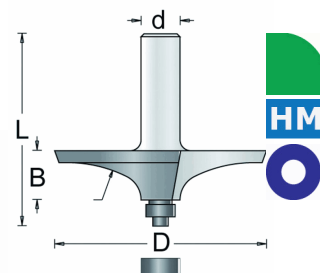
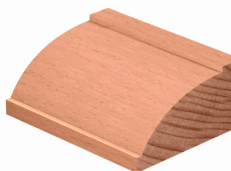

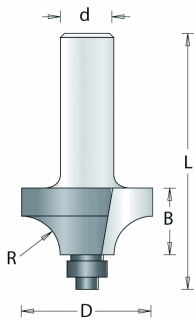

HM Kwartrondfrees

Toepassing: Vanaf 380-12 en groter Tmax: 18.000-16.000
Uitvoering: (Duivejager) met onderlager

Bestelnr.	D	B	L	R	d	P	U
76-6	22,2	12,7	49	4,8	6		
77-6	25,4	12,7	49	6,3	6		
78-6	28,6	12,7	49	7,9	6		
79-6	31,8	15,9	52	9,5	6		
80-6	38,1	19,1	55	12,7	6		
76-8	22,2	12,7	49	4,8	8		
77-8	25,4	12,7	49	6,3	8		
78-8	28,6	12,7	49	7,9	8		
79-8	31,8	15,9	52	9,5	8		
80-8	38,1	19,1	55	12,7	8		
376-8	44,5	22,2	61	15,9	8		
376-12	44,5	22,2	61	15,9	12		
377-12	50,8	25,4	75	19,1	12		
378-12	57,1	25,4	79	22,2	12		
379-12	63,5	31,8	92	25,4	12		
Tmax18000							
380-12	69,9	34,9	95	28,6	12		
384-12	72,6	38,7	98	30	12		
381-12	76,3	38,1	98	31,8	12		
Tmax16000							
385-12	82,7	42	91	35	12		
382-12	88,9	44,5	105	38,1	12		

Toebehoren:

Bestelnr.	Omschrijving	is voor:
KL40	Lager 9,5x3,2x4,8	
RB40	Ring lager 9,5x4,8	
SC10	Boutje NC5-3/8	
SR10	Ring boutje d=3,2	

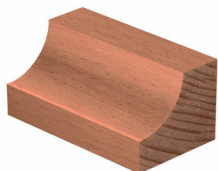
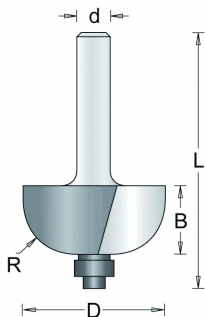

HM Holprofielfrees

Bestelnr.	D	B	L	R	d	P	U
83-6	22,2	14,3	52	6,3	6	A	
84-6	25,4	14,3	52	7,9	6	A	
85-6	28,6	14,3	52	9,5	6	A	
86-6	34,9	19,1	57	12,7	6	A	
83-8	22,2	14,3	52	6,3	8	A	
84-8	25,4	14,3	52	7,9	8	A	
85-8	28,6	14,3	52	9,5	8	A	
86-8	34,9	19,1	57	12,7	8	A	
86-12	34,9	19,1	57	12,7	12	A	
286-12	57,1	31,8	81	22,2	12	B	
386-12	41,3	18	65	16	12	B	

Toebehoren:

Bestelnr.	Omschrijving	is voor:
KL10	Lager 9,5x3,7x3,2	A
RB10	Ring lager 9,5x3,2	A
SC70	Boutje NC3-3/8	A
SR40	Ring boutje d=2,4	A
KL70	Lager 12,7x5x4,8	B
RB70	Ring lager 12,7x4,8	B
SC10	Boutje NC5-3/8	B
SR10	Ring boutje d=3,2	B

Randen bewerken

HM Afrondfrees Set Schuin

Uitvoering: Verstelbaar en dubbelzijdig met schuine snijkanten

Bestelnr.	D	B	L	a1	a2	d	P	U
156-12	34,8	42	108	45	30	12		

Toebehoren:

Bestelnr.	Omschrijving	is voor:
KL130/116	Lager 22x7x8	
RB110	Vulring 16x1x8	
RB130	Vulring 16x0,5x8	
RB150	Vulring 16x3x8	
RB160	Vulring 16x6x8	
RB1000	Vulring 16x0,1x8	

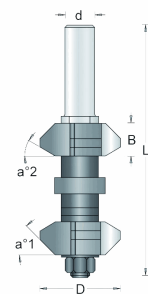
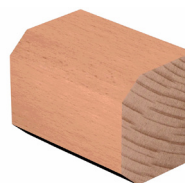

HM Afrondfrees Set Afgerond

Uitvoering: Verstelbaar en dubbelzijdig met afgeronde snijkanten

Bestelnr.	D	B	L	R1	R2	d	P	U
232-12	34,8	38	108	4,8	6,3	12		

Toebehoren:

Bestelnr.	Omschrijving	is voor:
KL130/116	Lager 22x7x8	
RB110	Vulring 16x1x8	
RB130	Vulring 16x0,5x8	
RB150	Vulring 16x3x8	
RB160	Vulring 16x6x8	
RB1000	Vulring 16x0,1x8	

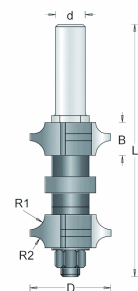
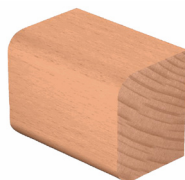

HM Kraalprofielfrees

Uitvoering: Met onderlager

Bestelnr.	D	B	L	R	d	P	U
160-6	22,2	14,3	54	3,2	6	A	
161-6	28,2	16,5	57	5	6	B	
162-6	31,8	19,1	58	6,3	6	B	
160-8	22,2	14,3	57	3,2	8	A	
161-8	28,2	16,5	57	5	8	B	
162-8	31,8	19,1	60	6,3	8	B	
261-12	38,1	25,4	75	9,5	12	B	

Toebehoren:

Bestelnr.	Omschrijving	is voor:
KL70	Lager 12,7x5x4,8	A
KL100	Lager 16x5x5	B

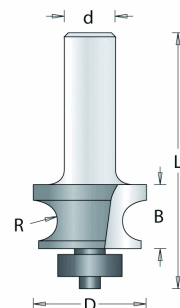
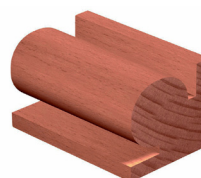

HM Kraalprofielfrees Ondersnijdend

Uitvoering: Met bovenlager en ondersnijdend

Bestelnr.	D	B	L	B1	R	d	P	U
275-8	19,1	32	75	14	9,5	8	A	
201-12	28,5	40	92	22,2	12,7	12	B	
201-12ZL	28,5	40	92	22,2	12,7	12		

Toebehoren:

Bestelnr.	Omschrijving	is voor:
KL250	Lager 19x5x8	A
LR230	Borgring 16x8x5	A
KL180	Lager 28,6x7,9x12,7	B
LR200	Borgring 20x12,7x6	B

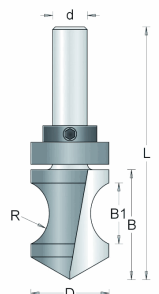

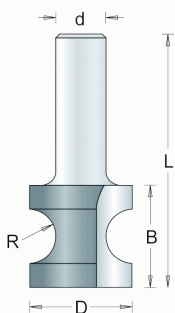

HM Kraalprofielfrees 8mm

Uitvoering:

Bestelnr.	D	B	L	R	d	P	U
202-8	22,2	19,1	51	5,2	8		
203-8	26,2	25,4	58	6,8	8		

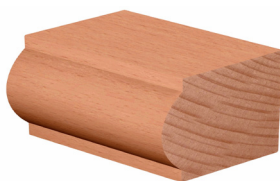
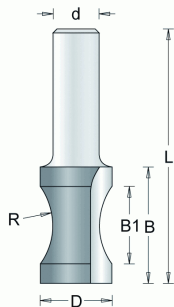

HM Kraalprofielfrees Grote Radius

Uitvoering: Grote radius

Bestelnr.	D	B	L	R	B1	d	P	U
226-8	20	32	21,3	64	18	8		

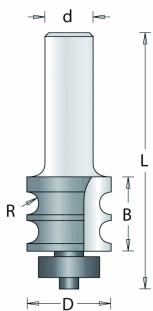

HM Dubbel kraalprofielfrees

Uitvoering: Met onderlager

Bestelnr.	D	B	L	R	d	P	U
227-8	22,2	19,1	65	3	8		

Toebehoren:

Bestelnr.	Omschrijving	is voor:
KL100	Lager 16x5x5	

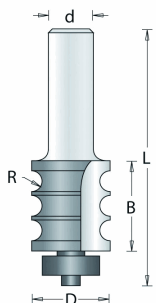

HM Drievoudige Kraalprofielfrees

Uitvoering: Met onderlager

Bestelnr.	D	B	L	R	d	P	U
228-8	22,2	25,4	65	3	8		

Toebehoren:

Bestelnr.	Omschrijving	is voor:
KL100	Lager 16x5x5	

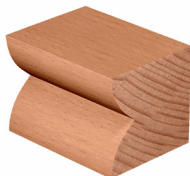
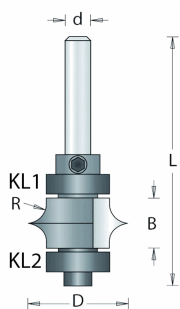

HM V-Groeffrees

Uitvoering: Afgeronde kanten met boven- en onderlager

Bestelnr.	D	B	L	R	d	P	U
229-6	28,6	15,9	69	6,3	6		

Toebehoren:

Bestelnr.	Omschrijving	is voor:
KL140/260	Lager 19x7x6,35	KL1
KL150	Lager 19x5x4,8	KL2
LR110	Borgring 11x6,35x5	

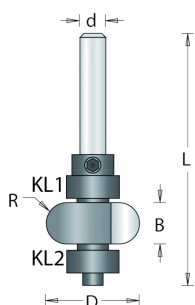

HM Holprofielgroeffrees

Uitvoering: Met boven- en onderlager

Bestelnr.	D	B	L	R	d	P	U
274-6	19,1	6,4	57	3,2	6		
236-6	22,7	10	61	5	6		

Toebehoren:

Bestelnr.	Omschrijving	is voor:
KL30	Lager 12,7x4,8x6,35	
KL70	Lager 12,7x5x4,8	
LR110	Borgring 11x6,35x5	

Profielgroeven en Graveren

HM Holprofielfrees

Bestelnr.	D	B	L	R	d	P	U
60-6	3,2	9,5	44	1,6	6		
61-6	4,8	12,7	47	2,4	6		
62-6	6,3	11	47	3,2	6		
63-6	9,5	6,3	38	4,8	6		
63-6-XL	9,5	6,3	70	4,8	6		
64-6	12,7	7,9	38	6,3	6		
65-6	15,9	9,5	38	7,9	6		
66-6	19,1	12,7	38	9,5	6		
60-8	3,2	9,5	44	1,6	8		
61-8	4,8	12,7	47	2,4	8		
62-8	6,3	11	47	3,2	8		
314-8	8	5,3	40	4	8		
63-8	9,5	6,3	38	4,8	8		
64-8	12,7	7,9	38	6,3	8		
65-8	15,9	9,5	38	7,9	8		
66-8	19,1	12,7	38	9,5	8		
262-8	22,2	13,8	45	11	8		
263-8	25,4	17,5	50	12,7	8		
262-12	22,2	13,8	52	11	12		
263-12	25,4	17,5	56	12,7	12		
264-12	32	32	70	16	12		
265-12	38,1	32	70	19,1	12		
266-12	50,8	32	70	25,4	12		

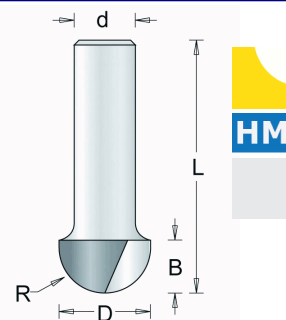
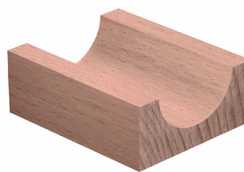

HM Holprofielfrees met bovenlager

Uitvoering: Met bovenlager

Bestelnr.	D	B	L	R	d	P	U
186-6	12,7	9,5	51	6,35	6		

Toebehoren:

Bestelnr.	Omschrijving	is voor:
KL30	Lager 12,7x4,8x6,35	
LR110	Borgring 11x6,35x5	

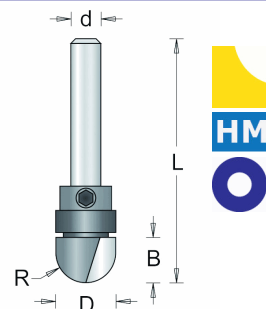
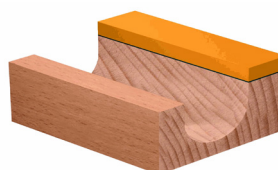

HM Holprofielfrees Extra snijhoogte

Uitvoering: Met extra snijhoogte

Bestelnr.	D	B	L	R	d	P	U
182-6	18	19	51	9	6		
182-8	18	19	51	9	8		
183-12	16	32	70	8	12		

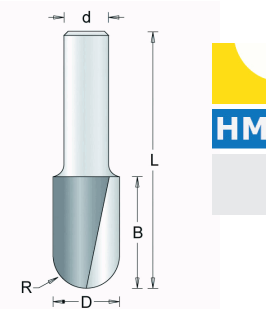
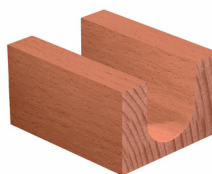

HM Holprofielfrees Afgeplat

Uitvoering: Met bovenlager voor bijvoorbeeld randen in houten borden

Bestelnr.	D	B	L	R	d	P	U
184-6	12,7	12,7	54	3	6	B	
185-6	19,1	16	60	6,5	6	A	

Toebehoren:

Bestelnr.	Omschrijving	is voor:
KL30	Lager 12,7x4,8x6,35	A
KL140/260	Lager 19x7x6,35	B
LR110	Borgring 11x6,35x5	AB

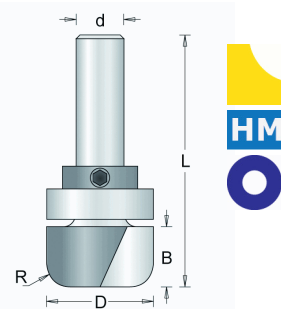

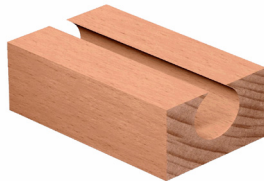
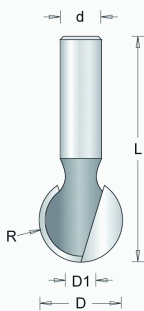

HM Bolkopfreese

Uitvoering:	R= 9,5						
Bestelnr.	D	D1	L	R	d	P	U
128-12	19	8	64	9,5	12		

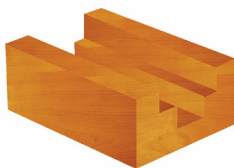
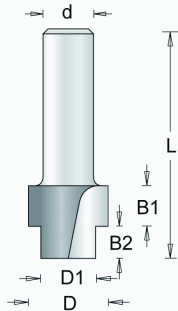

HM Getrapte freese

Uitvoering:	Voor meerpuntsluitingen							
Bestelnr.	D	D1	L	B1	B2	d	P	U
300-8	24,3	15,3	80	10	7	8		
305-8	20,3	12,3	60	10	6	8		

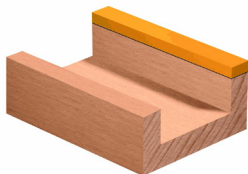
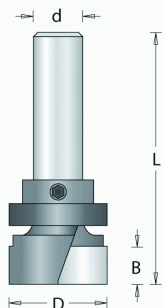

HM Bodemvlakfreese

Uitvoering:	Met bovenlager					
Bestelnr.	D	B	L	d	P	U
129-12	38,1	16	69	12		

Toebehoren:

Bestelnr.	Omschrijving	is voor:
KL9221	Lager 38,1x9x15	
LR200	Borgring 20x12,7x6	

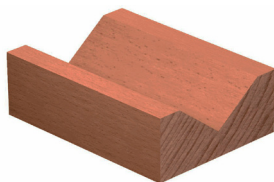
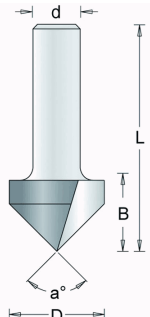

HM V-Groeffreese

Uitvoering:	a= 60-90°						
Bestelnr.	D	B	L	a	d	P	U
67-6	12,7	16	45	60	6		
67-8	12,7	16	47	60	8		
68-6	12,7	12,7	42	90	6		
69-6	19,1	16	45	90	6		
169-6	25,4	19,1	48	90	6		
68-8	12,7	12,7	44	90	8		
69-8	19,1	16	48	90	8		
169-8	25,4	19,1	51	90	8		
267-12	31,8	25,4	64	90	12		
268-12	38,1	31,8	70	90	12		
269-12	51	44,5	83	90	12		

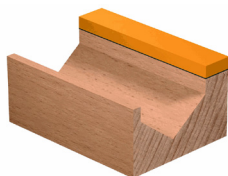
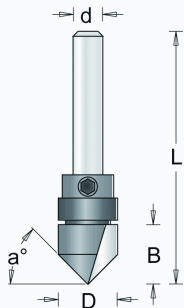

HM V-Groeffreese 45°

Uitvoering:	Met bovenlager; a= 45°						
Bestelnr.	D	B	L	a	d	P	U
244-6	12,7	12,7	52	45	6		

Toebehoren:

Bestelnr.	Omschrijving	is voor:
KL30	Lager 12,7x4,8x6,35	
LR110	Borgring 11x6,35x5	

HM Graveerfrees 60°

Uitvoering: Z=3; Met vol HM kop; a= 60°

Bestelnr.	D	B	L	a	d	P	U
180-6	14	22,2	57	60	6		
180-8	14	22,2	57	60	8		

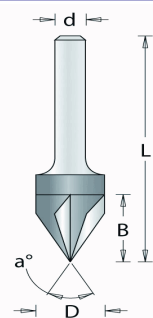

Vol HM Graveerfrees 60°

Uitvoering: Z=3; V-Groef vol HM kop; a= 60°

Bestelnr.	D	B	L	a	d	P	U
223-8	8	7	70	60	8		

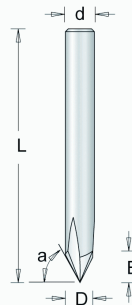

Vol HM Graveerfrees Holprofiel

Uitvoering: Holprofiel; Vol HM kop

Bestelnr.	D	B	L	R	d	P	U
224-8	8	11	70	4	8		

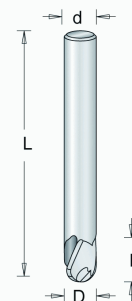

HM Graveerfreeshouder voor CNC machines

Toepassing: Complete set voor CNC machines. 320-8SET bevat 7 parts, waaronder drie maal part A.

Uitvoering: Z=1; Voor HM wisselmessen (apart te bestellen)

Bestelnr.	D	B	L	a	d	P	U
320-8	12		65		8		
320-8SET	12		65		8	ABCDE	
320A	1			30		A	
320B	1			90		B	
320C	1			60		C	
320D	3,2	3,2				D	
320E	3,5	3,3				E	

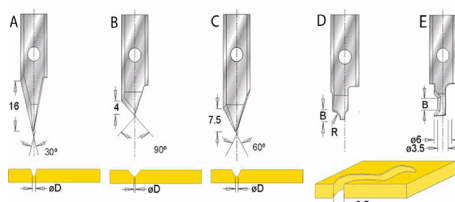
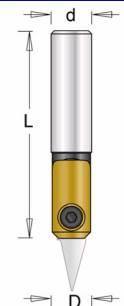

HM Fasefrees

Uitvoering: Z=2; Ondersnijdend

Bestelnr.	D	B	L	a	d	P	U
139-6	12,7	12,7	38	15	6		
140-6	22,2	10	39	23	6		
141-6	25,4	10	39	30	6		
142-6	34,2	10	39	45	6		
140-8	22,2	10	42	23	8		
141-8	25,4	10	42	30	8		
142-8	34,2	10	42	45	8		

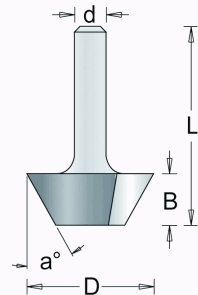
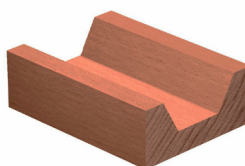

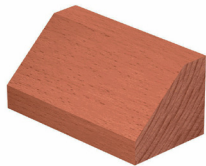
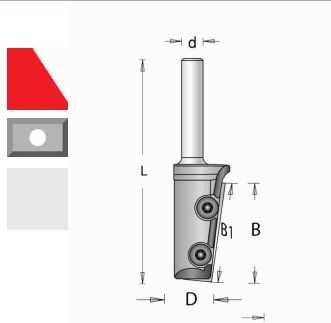

HM Fasefrees met wisselmessen

Toepassing: Tmax: 18.000

Uitvoering: Z=1

Bestelnr.	D	B	L	a	B1	d	P	U
306-8	21,3	29,2	69	7,5	29,5	8		
307-8	27	29,1	69	10	29,5	8		
308-8	32	28,5	69	15	29,5	8		

Toebehoren:

Bestelnr.	Omschrijving	is voor:
LV3012	Mes 29,5x12x1,5/4sn	
SC3548	Boutje Torx M3,5x4,8	
SLT15	Torx sleutel T15	

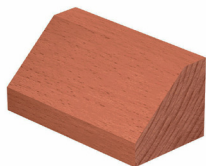
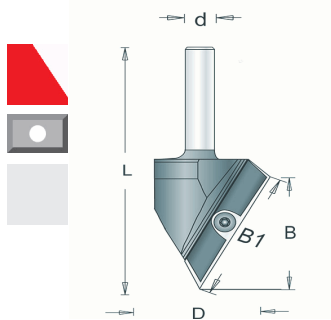

HM Fasefrees met wisselmessen

Toepassing: Tmax: 18.000

313-8 = Tmax: 12.000

Uitvoering: Z=1

Bestelnr.	D	B	L	a	B1	d	P	U
309-8	20,8	25	60	22,2	27	8	A	
310-8	22,8	24,5	65	25	27	8	A	
311-8	26	23,4	60	30	27	8	A	
312-8	31	22,1	66	35	27	8	A	
313-8	38,4	19	76,5	45	27	8	B	

Toebehoren:

Bestelnr.	Omschrijving	is voor:
L27	Mes 27x9x1,5/2sn	A
SC3548	Boutje Torx M3,5x4,8	AB
SLT15	Torx sleutel T15	AB
LV2812	Mes 28x12x1,5/4sn	B

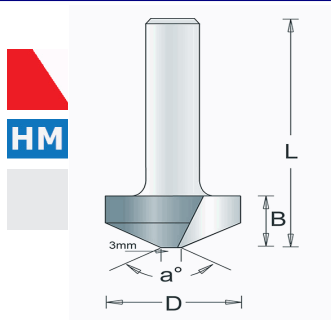

HM V-groeffrezen Alucobond

Uitvoering:

Bestelnr.	D	B	L	a	d	P	U
315-8	18	8	60	90	8		
316-8	18	3,3	60	135	8		

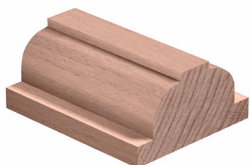
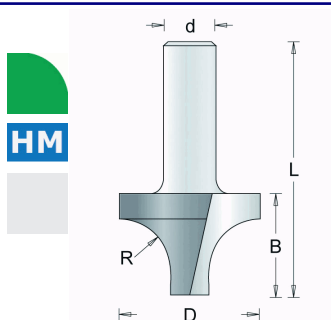

HM Afrondfrees

Ondersnijdend, voor binnenwerk

Uitvoering:

Bestelnr.	D	B	L	R	d	P	U
98-6	19,1	12,7	41	6,3	6		
99-6	22,2	14,3	43	7,9	6		
199-6	25,4	15,9	44	9,5	6		
98-8	19,1	12,7	41	6,3	8		
99-8	22,2	14,3	43	7,9	8		
199-8	25,4	15,9	48	9,5	8		

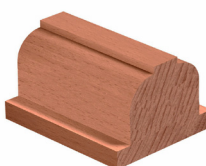
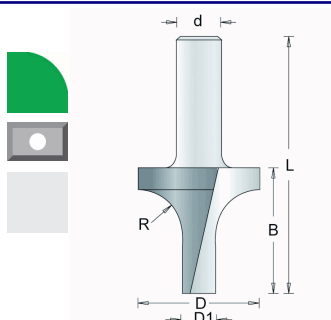

HM Afrondfrees Extra Lang

Ondersnijdend, voor binnenwerk

Uitvoering: Extra lang

Bestelnr.	D	B	L	D1	R	d	P	U
196-8	22	31	63	12	3	8		
198-8	34	38	70	12	8	8		

HM Afrondfrees Klein

Ondersnijdend, voor binnenwerk

Uitvoering: Klein

Bestelnr.	D	B	L	R	d	P	U
100-6	9,5	7,9	50	3,2	6		
100-8	9,5	7,9	50	3,2	8		

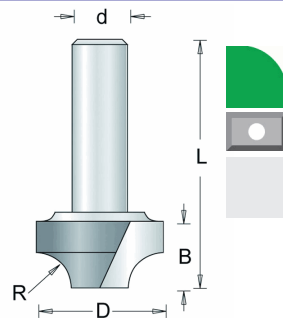
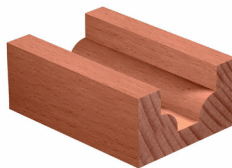

HM Profielfrees

Ondersnijdend

Bestelnr.	D	D1	B	L	R	d	P	U
101-6	12,7	5	9,5	50	2	6		
102-6	19,1	7	11,1	54	3,2	6		
101-8	12,7	5	9,5	50	2	8		
102-8	19,1	7	11,1	54	3,2	8		

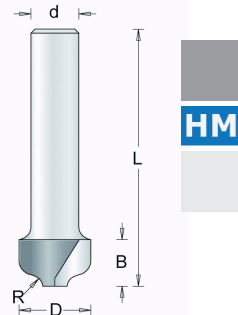
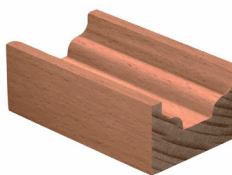

HM Profielfrees

Ondersnijdend

Bestelnr.	D	B	L	R1	R2	d	P	U
145-6	12,7	10,5	51	2,5	3,5	6		
146-6	19,1	12,7	54	3,7	4	6		
145-8	12,7	10,5	51	2,5	3,5	8		
146-8	19,1	12,7	54	3,7	4	8		

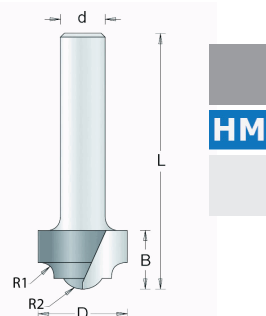
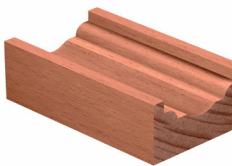

HM Profielfrees

Ondersnijdend

Bestelnr.	D	B	L	R	d	P	U
151-6	27	12	52	6	6		
151-8	27	12	52	6	8		

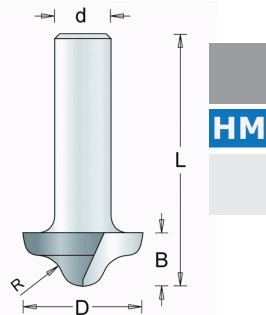
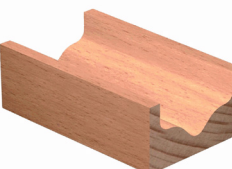

HM Profielfrees

Ondersnijdend

Uitvoering: Met bovenlager

Bestelnr.	D	B	L	R1	R2	d	P	U
147-6	22	12,7	51	4	5,5	6		
147-8	22	12,7	51	4	5,5	8		

Toebehoren:

Bestelnr.	Omschrijving	is voor:
KL130/116	Lager 22x7x8	
RR50	Klemring DIN471-8	

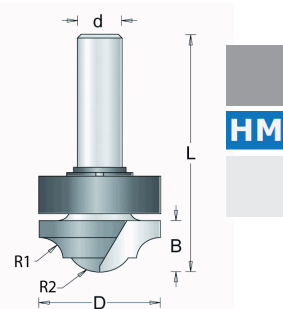
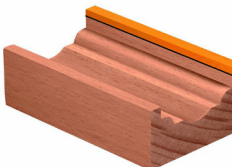

HM Profielfrees

Ondersnijdend

Uitvoering: Met bovenlager

Bestelnr.	D	B	L	R	d	P	U
148-6	22	9,5	51	2,4	6		
148-8	22	9,5	54	2,4	8		

Toebehoren:

Bestelnr.	Omschrijving	is voor:
KL130/116	Lager 22x7x8	
RR50	Klemring DIN471-8	

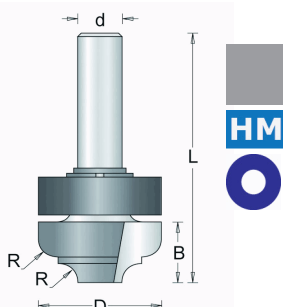
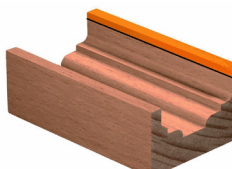

Handgrepen

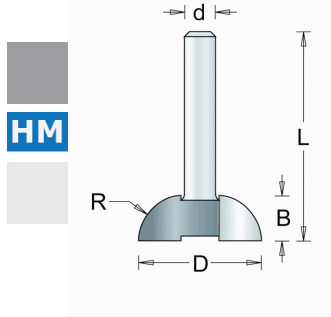

HM Vingergreepfrees d=6mm

Uitvoering:		Voor kastdeurtjes				
Bestelnr.	D	B	L	R	d	P U
163-6	19,1	6,3	45	6,5	6	
164-6	25,4	9,5	45	9,5	6	

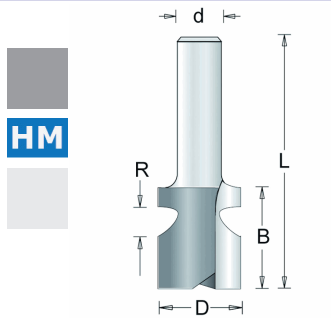

HM Vingergreepfrees d=12mm

Uitvoering:		Voor kastdeurtjes				
Bestelnr.	D	B	L	R	d	P U
165-12	22,2	20,6	59	1,6	12	

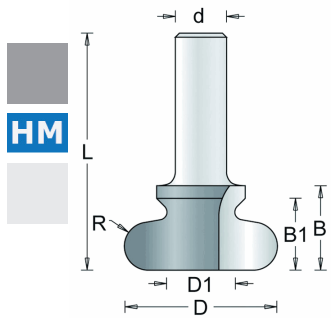

HM Vingergreepfrees d=12mm

Uitvoering:		Voor kastdeurtjes					
Bestelnr.	D	D1	B	B1	L	R	d P U
166-12	19,1	10	19,1	14,3	58	4,8	12
167-12	38,1	17	21	18	59	6	12
168-12	45	17	21	17,2	59	4,8	12

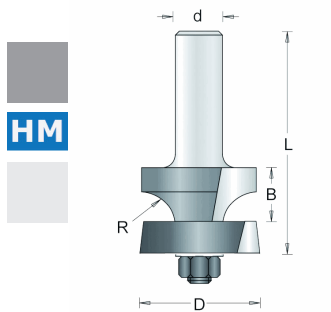

HM Afrond- en sponningfrees Set

Uitvoering:		Voor kastdeurtjes				
Bestelnr.	D	B	L	R	d	P U
179-12	41,3	25,4	76	9,5	12	

Toebehoren:		
Bestelnr.	Omschrijving	is voor:
RB110	Vulring 16x1x8	

Bossingpanelen

HM Bossingfrees

Uitvoering: Zware uitvoering

Bestelnr.	D	B	L	R	d	P	U
190-12	63,5	12,7	72	3	12		

Toebehoren:

Bestelnr.	Omschrijving	is voor:
KL70	Lager 12,7x5x4,8	

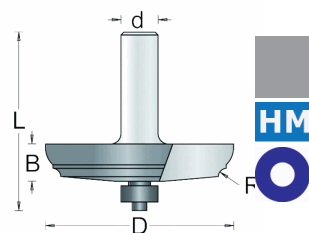
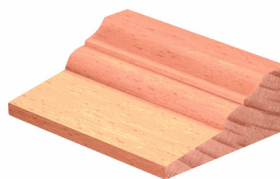

HM Bossingfrees

Uitvoering: Zware uitvoering

Bestelnr.	D	B	L	R	d	P	U
317-12	63,5	20	79	6,5	12		

Toebehoren:

Bestelnr.	Omschrijving	is voor:
KL70	Lager 12,7x5x4,8	

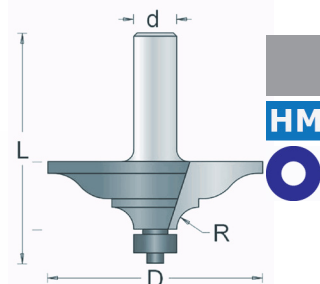

HM Bossingfrees Rond

Toepassing: Tmax 16.000

Uitvoering: Zware uitvoering; Rond

Bestelnr.	D	B	L	R	d	P	U
273-12	85,8	12,7	72	40	12		

Toebehoren:

Bestelnr.	Omschrijving	is voor:
KL70	Lager 12,7x5x4,8	

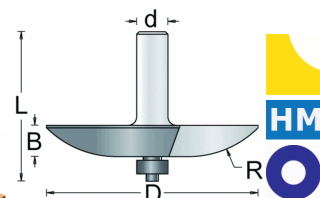
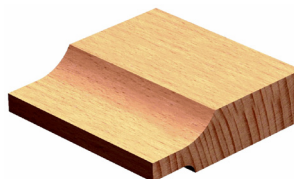

HM Bossingfrees Recht

Toepassing: Tmax 16.000

Uitvoering: Zware uitvoering; Recht

Bestelnr.	D	B	L	a	d	P	U
290-12	85,8	12,7	71	15	12		

Toebehoren:

Bestelnr.	Omschrijving	is voor:
KL70	Lager 12,7x5x4,8	

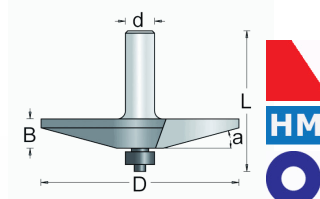

HM Bossingfrees S-vorm

Uitvoering: Zware uitvoering; S-vorm

Bestelnr.	D	B	L	R	d	P	U
117-12	66,7	15,9	65	17,5	12		
318-12	85,7	15,9	75	22	12		

Toebehoren:

Bestelnr.	Omschrijving	is voor:
KL70	Lager 12,7x5x4,8	

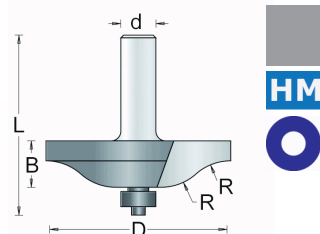

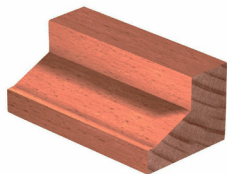
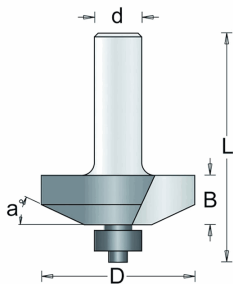

HM Bossingfrees Recht-Kort

Uitvoering: Zware uitvoering; Recht-Kort

Bestelnr.	D	B	L	a	d	P	U
289-8	41,3	12,7	62	25	8		
289-12	41,3	12,7	62	25	12		

Toebehoren:

Bestelnr.	Omschrijving	is voor:
KL70	Lager 12,7x5x4,8	

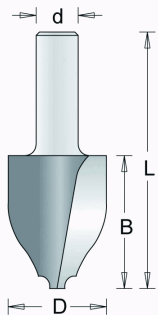

HM Verticale Bossingfrees (voor 8mm)

Toepassing: Tmax: 14.000

Uitvoering: Profiel; Speciaal voor 8mm

Bestelnr.	D	B	L	d	P	U
217-8 VP	30	41,3	79	8		

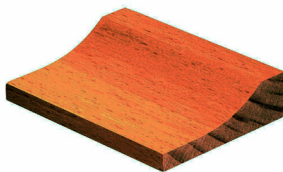
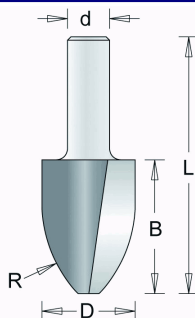

HM Verticale Bossingfrees Rond (voor 8mm)

Toepassing: Tmax: 14.000

Uitvoering: Rond; Speciaal voor 8mm

Bestelnr.	D	B	L	d	P	U
217-8 VR	28,6	41,3	79	8		

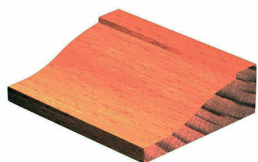
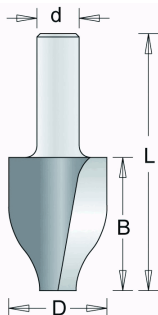

HM Verticale Bossingfrees S-vorm (8mm)

Toepassing: Tmax: 14.000

Uitvoering: S-vorm; Speciaal voor 8mm

Bestelnr.	D	B	L	d	P	U
217-8 VS	30	41,3	79	8		

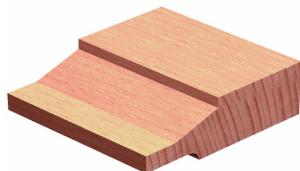
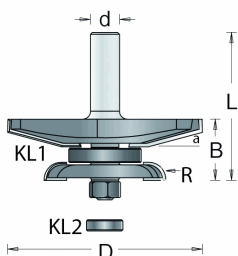

HM Bossingfrees Recht met ondermessen

Toepassing: Tmax: 12.000

Uitvoering: Recht; Met ondermessen

Bestelnr.	D	B	L	R	a	d	P	U
270-12	85,5	27,5	83	7,9	15	12		

Toebehoren:

Bestelnr.	Omschrijving	is voor:
KL9710	Lager 31,7x6,2x8	KL1
KL240	Lager 16x5x8	KL2
RB1150	Vulring 12x0,1	
RB1200	Vulring 12x0,05	
RB180	Vulring 12x1	

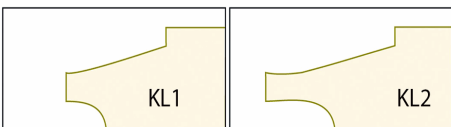

HM Bossingfrees Rond met ondermessen

Toepassing: Tmax: 12.000
Uitvoering: Rond; Met ondermessen

Bestelnr.	D	B	L	R1	R2	d	P	U
271-12	85,5	27,5	83	7,9	40	12		

Toebehoren:

Bestelnr.	Omschrijving	is voor:
KL9710	Lager 31,7x6,2x8	KL1
KL240	Lager 16x5x8	KL2
RB1150	Vulring 12x0,1	
RB1200	Vulring 12x0,05	
RB180	Vulring 12x1	

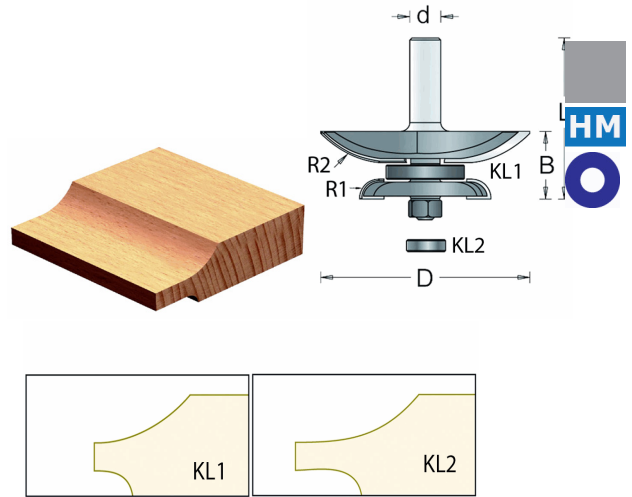

HM Bossingfrees Profiel met ondermessen

Toepassing: Tmax: 12.000
Uitvoering: Profiel; Met ondermessen

Bestelnr.	D	B	L	R	d	P	U
272-12	85,8	30,7	87	7,9	12		

Toebehoren:

Bestelnr.	Omschrijving	is voor:
KL9710	Lager 31,7x6,2x8	KL1
KL240	Lager 16x5x8	KL2
RB1150	Vulring 12x0,1	
RB1200	Vulring 12x0,05	
RB180	Vulring 12x1	

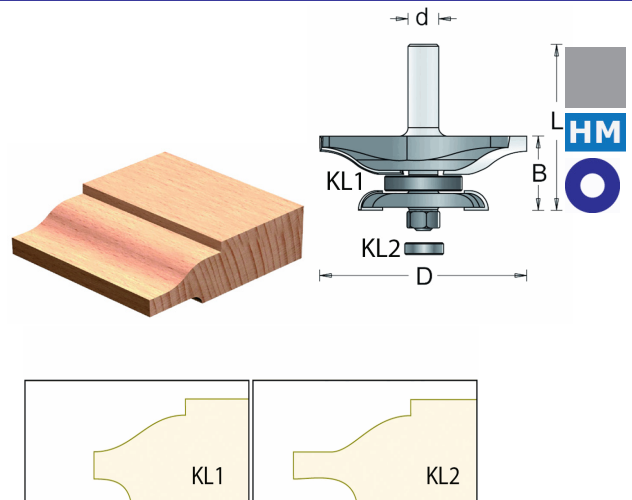

Paneeldeuren

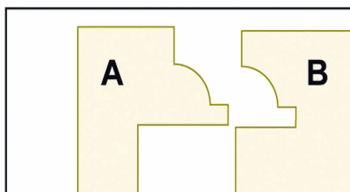
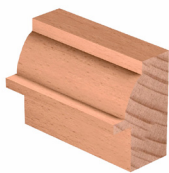
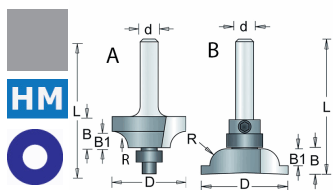

HM Profiel/Contra Profielrees Set

Uitvoering: De set 234-6 bevat 234A-6 en 234B-6

Bestelnr.	D	B	B1	L	R	d	P	U
234-6								
234A-6	27,5	11,5	6	50	6	6	A	
234B-6	30,7	9	6	47	6	6	B	

Toebehoren:

Bestelnr.	Omschrijving	is voor:
KL10	Lager 9,5x3,7x3,2	A
KL30	Lager 12,7x4,8x6,35	B
LR110	Borgring 11x6,35x5	B

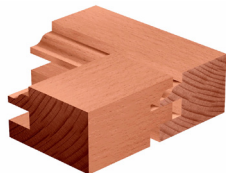
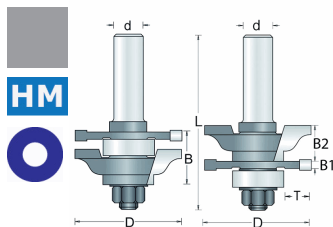

HM Profiel/Contra profielrees A

Uitvoering: Zware uitvoering

Bestelnr.	D	B	L	B1	B2	T	d	P	U
118A-8	46	22	70	4	15	12	8		
118A-12	46	22	76	4	15	12	12		

Toebehoren:

Bestelnr.	Omschrijving	is voor:
KL130/116	Lager 22x7x8	
RB110	Vulring 16x1x8	
RB1000	Vulring 16x0,1x8	
RB50	Ring 12,7x5x6,35	

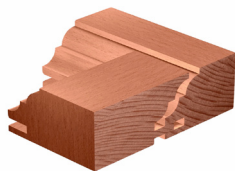
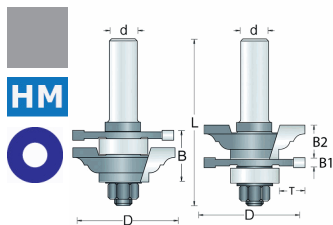

HM Profiel/Contra profielrees B

Uitvoering: Zware uitvoering

Bestelnr.	D	B	L	B1	B2	T	d	P	U
118B-8	46	22	70	4	15	12	8		
118B-12	46	22	76	4	15	12	12		

Toebehoren:

Bestelnr.	Omschrijving	is voor:
KL130/116	Lager 22x7x8	
RB110	Vulring 16x1x8	
RB1000	Vulring 16x0,1x8	
RB50	Ring 12,7x5x6,35	

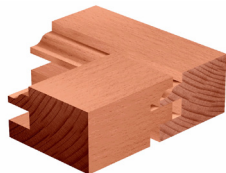
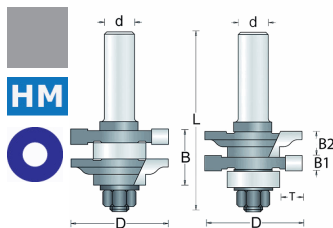

HM Profiel/Contra profielrees C

Uitvoering: Zware uitvoering

Bestelnr.	D	B	L	B1	B2	T	d	P	U
118C-8	41	22	70	6,3	11	9,5	8		
118C-12	41	22	76	6,3	11	9,5	12		

Toebehoren:

Bestelnr.	Omschrijving	is voor:
KL130/116	Lager 22x7x8	
RB110	Vulring 16x1x8	
RB1000	Vulring 16x0,1x8	
RB50	Ring 12,7x5x6,35	

HM Profiel/Contra profielrees D

Uitvoering: Zware uitvoering

Bestelnr.	D	B	L	B1	B2	T	d	P	U
118D-8	41	22	76	6,3	11	9,5	8		
118D-12	41	22	76	6,3	11	9,5	12		

Toebehoren:

Bestelnr.	Omschrijving	is voor:
KL130/116	Lager 22x7x8	
RB110	Vulring 16x1x8	
RB1000	Vulring 16x0,1x8	
RB50	Ring 12,7x5x6,35	

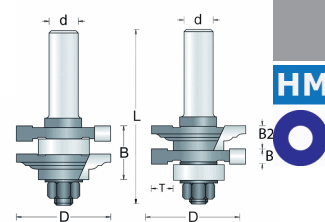
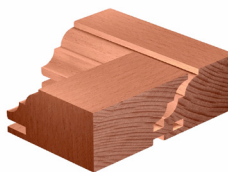

HM

HM Profiel/Contra profielrees E

Uitvoering: Zware uitvoering

Bestelnr.	D	B	L	B1	B2	T	d	P	U
118E-8	41	22	70	6,3	11	9,5	8		
118E-12	41	22	76	6,3	11	9,5	12		

Toebehoren:

Bestelnr.	Omschrijving	is voor:
KL130/116	Lager 22x7x8	
RB110	Vulring 16x1x8	
RB1000	Vulring 16x0,1x8	

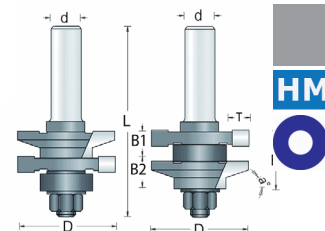
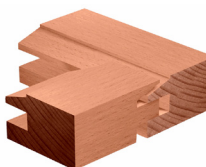

HM

HM Pen/Groeffrees Set

Bestelnr.	D	B	L	B1	T	d	P	U
246-8	41	19	70	6,35	9,5	8		
246-12	41	19	70	6,35	9,5	12		

Toebehoren:

Bestelnr.	Omschrijving	is voor:
KL130/116	Lager 22x7x8	
RB110	Vulring 16x1x8	
RB160	Vulring 16x6x8	
RB1000	Vulring 16x0,1x8	

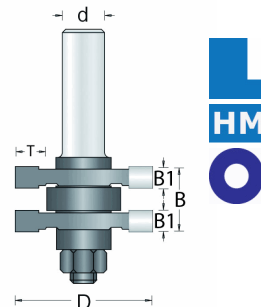
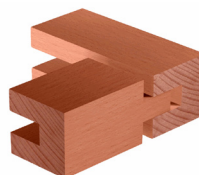

HM

Frezen

Verbindingen frezen

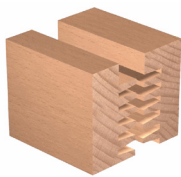
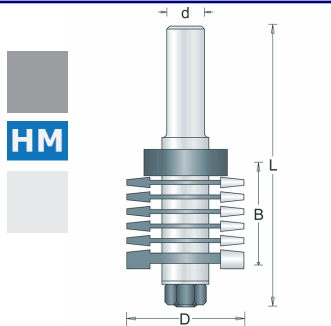

HM Verlijmfrees

Uitvoering: Vingerverlijmen van 11-36mm

Bestelnr.	D	B	L	d	P	U
6000-12	39,5	33	96	12		

Toebehoren:

Bestelnr.	Omschrijving	is voor:
KL160	Lager 28x9x8	

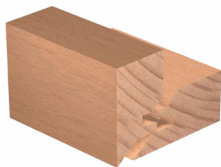
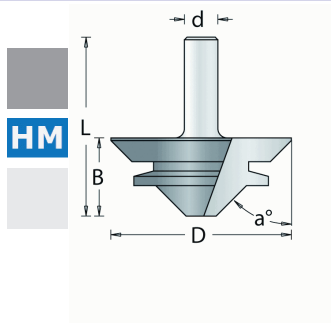

HM Verlijmfrees 45°

Toepassing: Tmax 18.000

Uitvoering: a = 45°; Minimale materiaalhoogte 14 mm

Bestelnr.	D	B	L	a	d	P	U
287-12	67	29,5	78	45	12		

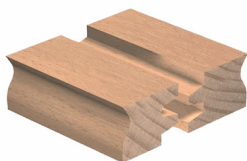
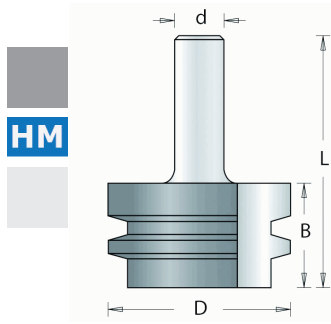

HM Verlijmfrees 90°

Uitvoering: a = 90°

Bestelnr.	D	B	L	a	d	P	U
178-12	47	28	66	90	12		

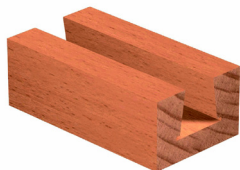
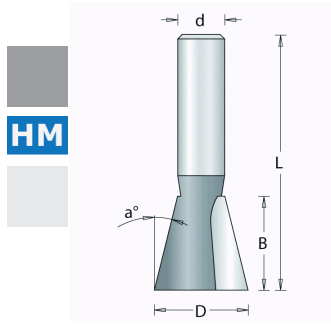

HM Zwaluwstaartfrees

Uitvoering: a = 9-14°

Bestelnr.	D	B	L	a	d	P	U
70-6	12,7	12,7	45	14	6		
296-8	9,5	9,5	42	9	8		
70-8	12,7	12,7	49	14	8		
297-8	19,4	19,1	65	14	8		
297-12	19,4	19,1	65	14	12		
298-12	25,4	25,4	70	14	12		

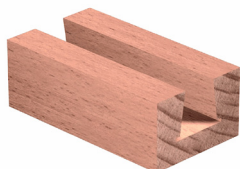
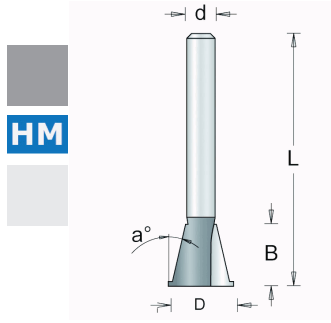

HM Zwaluwstaartfrees 13°

Uitvoering: Met lijmgroef (ritser); a = 13°

Bestelnr.	D	B	L	a	d	P	U
70-8-RXL	14,3	13,5	58	13	8		

HM Zwaluwstaartfrees 14°

Uitvoering: Met bovenlager; $\alpha = 14^\circ$

Bestelnr.	D	B	L	a	d	P	U
136-6	12,7	12,7	56	14	6		

Toebehoren:

Bestelnr.	Omschrijving	is voor:
KL30	Lager 12,7x4,8x6,35	
LR110	Borgring 11x6,35x5	

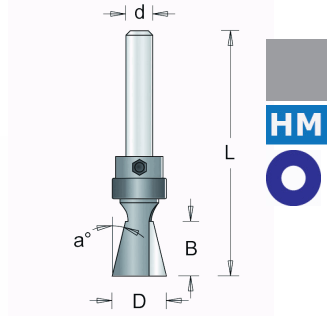

Profileren

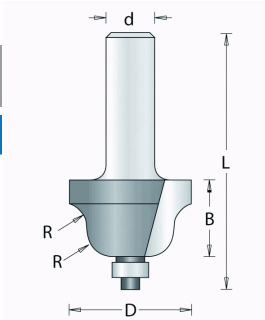

HM Romeinse Ogiefrees

Uitvoering:		Met onderlager				
Bestelnr.	D	B	L	R	d	P U
81xs-6	14,3	8	47	2,4	6	A
81-6	25,4	15,9	52	4	6	B
82-6	34,9	22,2	57	6,3	6	B
81-8	25,4	15,9	52	4	8	B
82-8	34,9	22,2	57	6,3	8	B

Toebehoren:

Bestelnr.	Omschrijving	is voor:
KLW48	Kogellager D=4,8	A
KL10	Lager 9,5x3,7x3,2	B
RB10	Ring lager 9,5x3,2	B
SR40	Ring boutje d=2,4	B
SC70	Boutje NC3-3/8	B

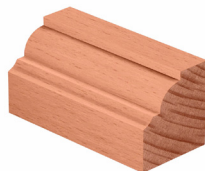
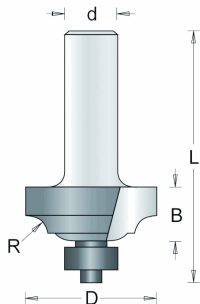

HM Profiefrees

Uitvoering:		Met onderlager				
Bestelnr.	D	B	L	R	d	P U
89-8	31,7	12,7	52	5	8	
89-6	31,7	12,7	53	5	6	
90-6	38,1	15,9	55,5	6	6	

Toebehoren:

Bestelnr.	Omschrijving	is voor:
KL70	Lager 12,7x5x4,8	
RB70	Ring lager 12,7x4,8	
SC10	Boutje NC5-3/8	
SR10	Ring boutje d=3,2	

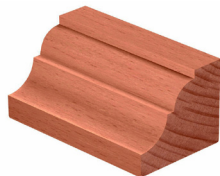
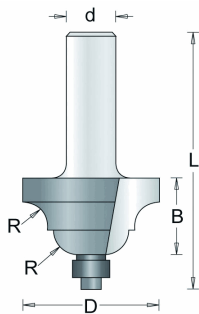

HM Profiefrees

Uitvoering:		Met onderlager				
Bestelnr.	D	B	L	R	d	P U
91-6	25,4	15,9	52	4	6	
92-6	34,9	22,2	57	6,3	6	
91-8	25,4	15,9	52	4	8	
92-8	34,9	22,2	57	6,3	8	

Toebehoren:

Bestelnr.	Omschrijving	is voor:
KL10	Lager 9,5x3,7x3,2	
RB10	Ring lager 9,5x3,2	
SC70	Boutje NC3-3/8	
SR40	Ring boutje d=2,4	

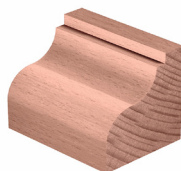
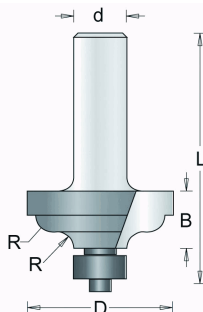

HM Profiefrees

Uitvoering:		Met onderlager klein				
Bestelnr.	D	B	L	R	d	P U
93-6	34,9	13,5	52	4,8	6	
93-8	34,9	13,5	52	4,8	8	

Toebehoren:

Bestelnr.	Omschrijving	is voor:
KL40	Lager 9,5x3,2x4,8	
RB40	Ring lager 9,5x4,8	
SC10	Boutje NC5-3/8	
SR10	Ring boutje d=3,2	

HM Profielrees

Uitvoering: Met onderlager

Bestelnr.	D	B	L	R	d	P	U
301-6	34,9	13,5	52	4,8	6		
301-8	34,9	13,5	52	4,8	8		

Toebehoren:

Bestelnr.	Omschrijving	is voor:
KL70	Lager 12,7x5x4,8	
RB70	Ring lager 12,7x4,8	
SC10	Boutje NC5-3/8	
SR10	Ring boutje d=3,2	

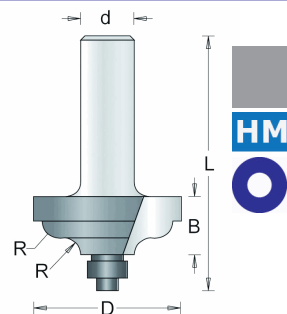

HM Profielrees

Uitvoering: Met onderlager klein

Bestelnr.	D	B	L	R	d	P	U
176-6	28,6	12,7	51	4	6		
177-6	34,9	17	55	5,5	6		
176-8	28,6	12,7	54	4	8		
177-8	34,9	17	58	5,5	8		

Toebehoren:

Bestelnr.	Omschrijving	is voor:
KL40	Lager 9,5x3,2x4,8	
RB40	Ring lager 9,5x4,8	
SC10	Boutje NC5-3/8	
SR10	Ring boutje d=3,2	

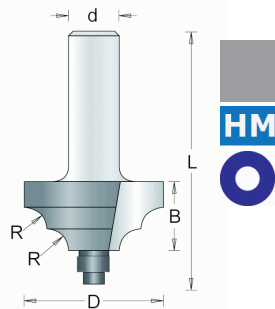
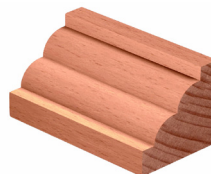

HM Profielrees

Uitvoering: Met onderlager

Bestelnr.	D	B	L	R1	R2	d	P	U
95-6	28,6	12,7	50	4	4	6		
94-6	34,9	17,5	55	4,8	6,3	6		
95-8	28,6	12,7	50	4	4	8		
94-8	34,9	17,5	55	4,8	6,3	8		

Toebehoren:

Bestelnr.	Omschrijving	is voor:
KL70	Lager 12,7x5x4,8	
RB70	Ring lager 12,7x4,8	
SC10	Boutje NC5-3/8	
SR10	Ring boutje d=3,2	

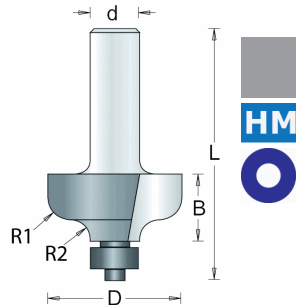
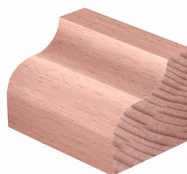

HM Profielrees

Uitvoering: Met onderlager klein

Bestelnr.	D	B	L	R1	R2	d	P	U
303-6	28,6	12,7	50	4	4	6		
302-6	34,9	17,5	55	6,3	4,8	6		
303-8	28,6	12,7	50	4	4	8		
302-8	34,9	17,5	55	6,3	4,8	8		

Toebehoren:

Bestelnr.	Omschrijving	is voor:
KL40	Lager 9,5x3,2x4,8	
RB40	Ring lager 9,5x4,8	
SC10	Boutje NC5-3/8	
SR10	Ring boutje d=3,2	

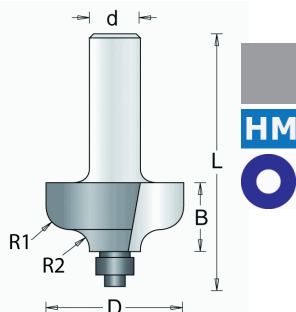

Frezen

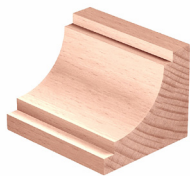
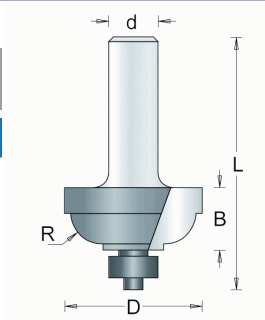

HM Profiefrees

Uitvoering: Met onderlager

Bestelnr.	D	B	L	R	d	P	U
96-6	34,9	15,9	54	7,9	6		
97-6	28,6	12,7	50	4,8	6		
97-8	28,6	12,7	50	4,8	8		

Toebehoren:

Bestelnr.	Omschrijving	is voor:
KL70	Lager 12,7x5x4,8	
RB70	Ring lager 12,7x4,8	
SC10	Boutje NC5-3/8	
SR10	Ring boutje d=3,2	

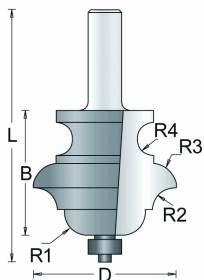

HM MultiProfiefrees

Toepassing: Tmax 18.000

Uitvoering: Met onderlager

Bestelnr.	D	B	L	R1	R2	R3	R4	d	P	U
299-12	54	47	97	9	9	8,5	6.3	12		

Toebehoren:

Bestelnr.	Omschrijving	is voor:
KL70	Lager 12,7x5x4,8	

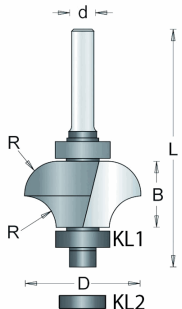

HM MultiProfiefrees Octocut

Uitvoering: Met onderlager

Bestelnr.	D	B	L	R	d	P	U
137-8	31,8	17	69	8	8		

Toebehoren:

Bestelnr.	Omschrijving	is voor:
KL240	Lager 16x5x8	KL1
KL310	Lager 14x4x8	KL2

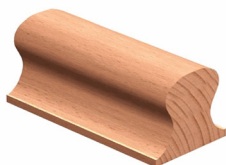
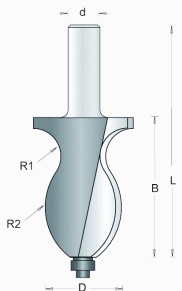
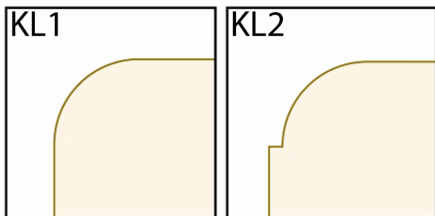

HM Trapeuningprofiefrees

Uitvoering: Met onderlager

Bestelnr.	D	B	L	R1	R2	d	P	U
155-12	46	58,8	108	28,5	12,7	12		

Toebehoren:

Bestelnr.	Omschrijving	is voor:
KL70	Lager 12,7x5x4,8	

HM Profielrees

Uitvoering: Met onderlager

Bestelnr.	D	B	L	R1	R2	d	P	U
170-6	28,6	12,7	53	4	4	6		
171-6	34,9	17,5	57	6	5	6		
170-8	28,6	12,7	56	4	4	8		
171-8	34,9	17,5	60	6	5	8		

Toebehoren:

Bestelnr.	Omschrijving	is voor:
KL70	Lager 12,7x5x4,8	
RB70	Ring lager 12,7x4,8	
SC10	Boutje NC5-3/8	
SR10	Ring boutje d=3,2	

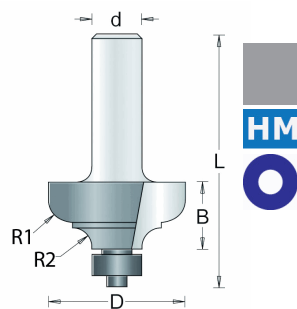

HM Profielrees

Uitvoering: Met onderlager klein

Bestelnr.	D	B	L	R1	R2	d	P	U
172-6	28,6	12,7	51	4	4	6		
173-6	34,9	17,5	55	6	5	6		
172-8	28,6	12,7	54	4	4	8		
173-8	34,9	17,5	59	6	5	8		

Toebehoren:

Bestelnr.	Omschrijving	is voor:
KL40	Lager 9,5x3,2x4,8	
RB40	Ring lager 9,5x4,8	
SC10	Boutje NC5-3/8	
SR10	Ring boutje d=3,2	

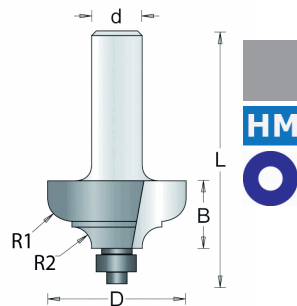
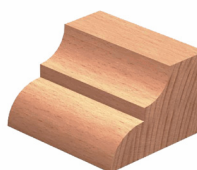

HM Profielrees

Uitvoering: Met onderlager

Bestelnr.	D	B	L	R	d	P	U
174-6	28,6	12,7	53	4	6		
175-6	34,9	17	57	5,5	6		
174-8	28,6	12,7	57	4	8		

Toebehoren:

Bestelnr.	Omschrijving	is voor:
KL70	Lager 12,7x5x4,8	
RB70	Ring lager 12,7x4,8	
SC10	Boutje NC5-3/8	
SR10	Ring boutje d=3,2	

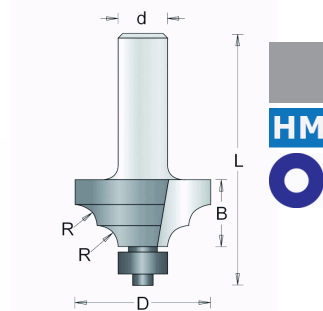

Corian Frezen

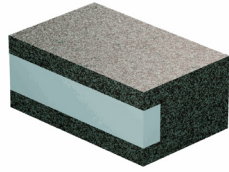
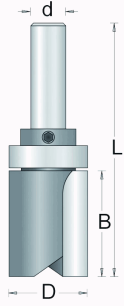

HM Kopieerfrees Corian

Uitvoering: Een speciale frezenlijn voor massief kunststof (keuken-)bladen

Bestelnr.	D	B	L	d	P	U
375-12	28,6	38,1	92	12		

Toebehoren:

Bestelnr.	Omschrijving	is voor:
KL180	Lager 28,6x7,9x12,7	
LR200	Borgring 20x12,7x6	

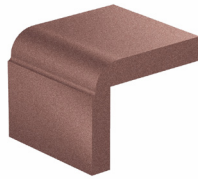
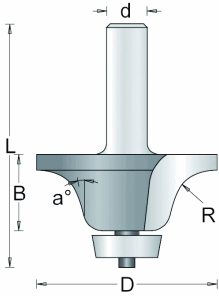

HM Ogieffrees Corian

Toepassing: Voor ondermontage wasbak

Uitvoering: Met Delrin onderlager

Bestelnr.	D	B	L	a	R	d	P	U
396-12	55	25,4	75	15	13	12		
397-12	61	32	86	15	14	12		

Toebehoren:

Bestelnr.	Omschrijving	is voor:
KLD320	Lager 21,8x6,7x6,35	

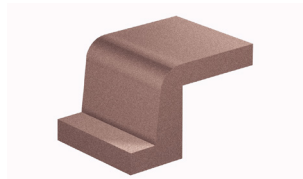
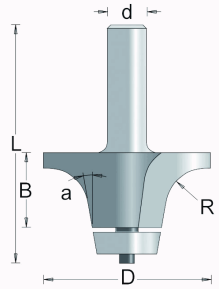

HM Afrondfrees Corian

Toepassing: Voor ondermontage wasbak

Uitvoering: Met Delrin onderlager

Bestelnr.	D	B	L	a	R	d	P	U
398-12	54	25,4	79	18	13	12		
399-12	57	32	85	18	14	12		

Toebehoren:

Bestelnr.	Omschrijving	is voor:
KLD320	Lager 21,8x6,7x6,35	

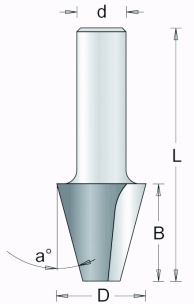

HM Fasefrees Corian 15°

Uitvoering: a = 15°

Bestelnr.	D	B	L	a	d	P	U
390-12	24	25,4	65	15	12		

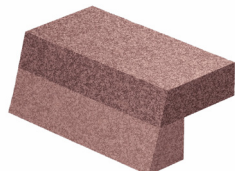
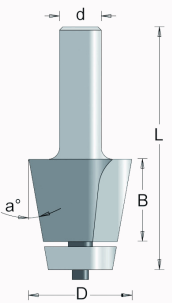

HM Fasefrees Corian met onderlager

Uitvoering: Met Delrin onderlager; a = 12°

Bestelnr.	D	B	L	a	d	P	U
393-12	32	25,4	80	12	12		

Toebehoren:

Bestelnr.	Omschrijving	is voor:
KLD320	Lager 21,8x6,7x6,35	

HM Fasefrees Corian met bovenlager

Uitvoering: Met Delrin bovenlager; $a = 12^\circ$

Bestelnr.	D	B	L	a	d	P	U
391-12	28,6	25,4	78	12	12		

Toebehoren:

Bestelnr.	Omschrijving	is voor:
KL180	Lager 28,6x7,9x12,7	
LR200	Borgring 20x12,7x6	

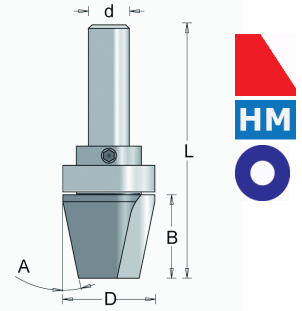
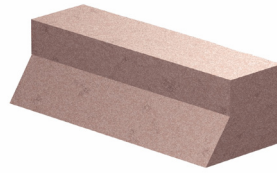

HM Zwaluwstaart met Bovenlager

Uitvoering: Met Delrin bovenlager; $a = 12^\circ$

Bestelnr.	D	B	L	a	d	P	U
392-12	28,6	26	79	12	12		

Toebehoren:

Bestelnr.	Omschrijving	is voor:
KL180	Lager 28,6x7,9x12,7	
LR200	Borgring 20x12,7x6	

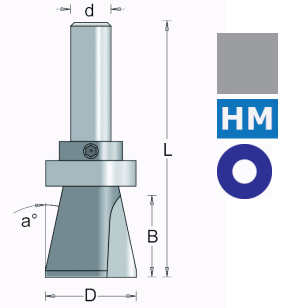

HM Bladrandfrees Corian

Uitvoering: Met Delrin onderlager

Bestelnr.	D	B	B1	L	R	d	P	U
394-12	25	23	16	77	8	12		
395-12	25	29	24	83	8	12		

Toebehoren:

Bestelnr.	Omschrijving	is voor:
KLD340	Lager 19x6,35x6,35	

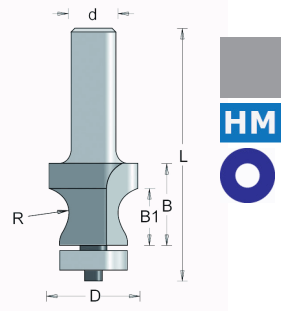
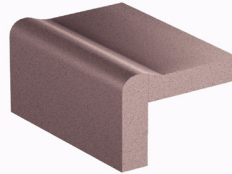

Speciale toepassingen

HM

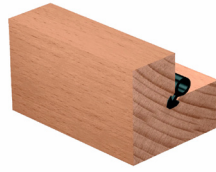

HM Frees voor tochtstrip Pijlpunt

Uitvoering: Voor strip met "Pijlpunt"

Bestelnr.	D	B	L	a	D1	B1	d	P	U
293-6	5,5	8	65	38	2	4	6		

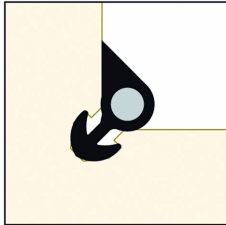
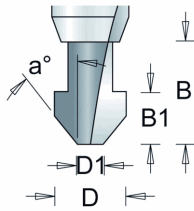

HM

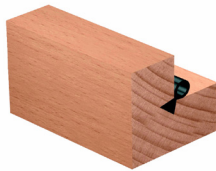
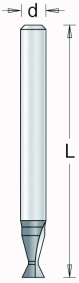

HM Frees voor tochtstrip Zwaluwstaart

Uitvoering: Voor strip met "Zwaluwstaart"

Bestelnr.	D	B	L	a	d	P	U
294-6	5,1	8	60	25	6		

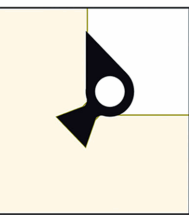
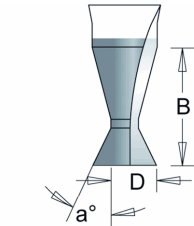

HM

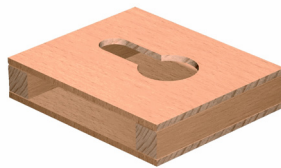
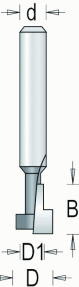

HM Sleutelgat Profiefrees

Uitvoering: d = 6 - 8mm

Bestelnr.	D	D1	B	L	d	P	U
150-6	9,5	5	11	42	6		
150-8	9,5	5	9,5	45	8		
157-8	12,7	8	9,5	38	8		

HM

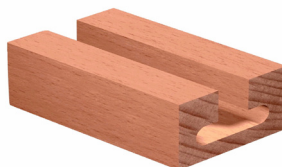
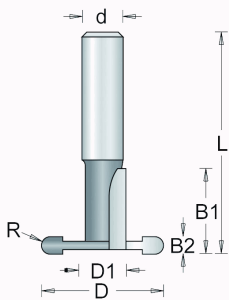

HM T-Slotfrees

Uitvoering: Afgeronde hoeken

Bestelnr.	D	D1	B1	B2	L	R	d	P	U
291-12	28,8	11,1	20,7	4	55	2	12		

HM T-Slotfrees Recht

Uitvoering: Rechte hoeken

Bestelnr.	D	D1	B1	B2	L	d	P	U
292-12	35	12,7	22,2	9,5	65	12		

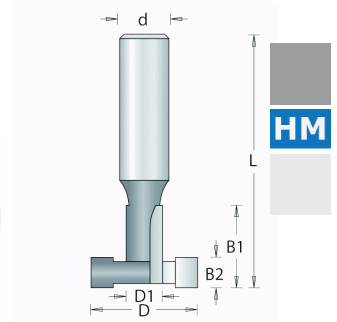
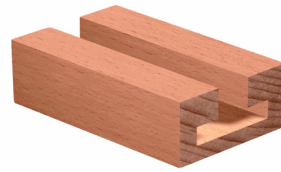

Amaxx Frezen vaste messen

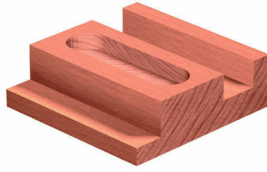
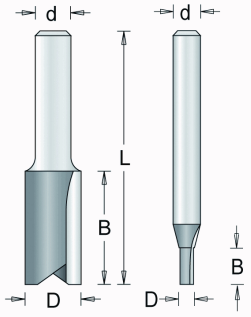

HM Amaxx Groeffrees

Uitvoering: Z=2; d=8 mm

Bestelnr.	D	B	L	d	P	U
601-6	5	12,7	48	6		
602-6	6	20	48	6		
603-6	8	20	48	6		
604-6	10	20	48	6		
605-6	12	20	48	6		
606-6	14	20	48	6		
607-6	16	20	48	6		
608-6	18	20	48	6		
609-6	20	20	48	6		
601-8	5	12,7	48	8		
602-8	6	20	48	8		
603-8	8	20	48	8		
604-8	10	20	48	8		
605-8	12	20	48	8		
606-8	14	20	48	8		
607-8	16	20	48	8		
608-8	18	20	48	8		
609-8	20	20	48	8		

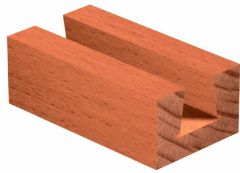
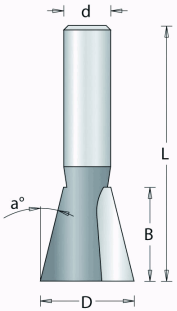

HM Amaxx Zwaluwstaartfrees

Uitvoering: a = 14°

Bestelnr.	D	B	L	a	d	P	U
610-6	12,7	12,7	45	14	6		
610-8	12,7	12,7	45	14	8		

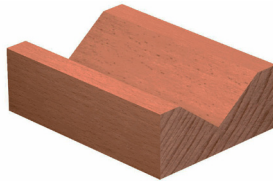
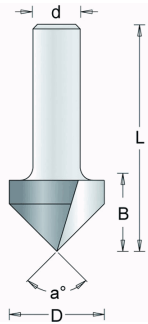

HM Amaxx V-Groeffrees

Uitvoering: a = 60-90°

Bestelnr.	D	B	L	a	d	P	U
611-6	9,5	10	44	60	6		
612-6	12,7	8	40	90	6		
611-8	9,5	10	44	60	8		
612-8	12,7	8	40	90	8		

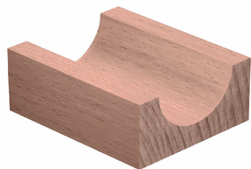
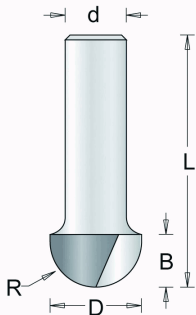

HM Amaxx Holprofielfrees

Uitvoering: R = 3,2 - 6,3

Bestelnr.	D	B	L	R	d	P	U
613-6	6,3	5	40	3,2	6		
614-6	12,7	8	40	6,3	6		
613-8	6,3	5	40	3,2	8		
614-8	12,7	8	40	6,3	8		

HM Amaxx Profiefrees

Bestelnr.	D	B	L	R1	R2	d	P	U
615-6	12,7	8	40	4	3,2	6		
615-8	12,7	8	40	4	3,2	8		

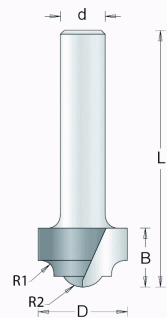
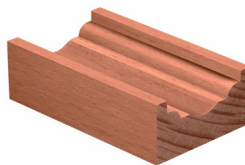

HM Amaxx Kantenfrees

Uitvoering: Met onderlager

Bestelnr.	D	B	L	d	P	U
616-6	12,7	12,7	54	6		
616-8	12,7	12,7	54	8		

Toebehoren:

Bestelnr.	Omschrijving	is voor:
KL70	Lager 12,7x5x4,8	

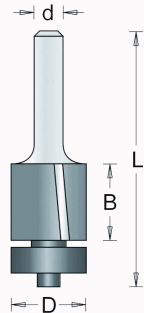
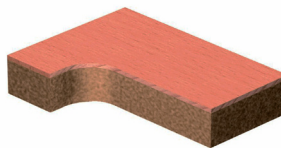

HM Amaxx Kantenfrees 25-45°

Uitvoering: Met onderlager; $\alpha = 25 - 45^\circ$

Bestelnr.	D	B	L	a	d	P	U
617-6	16	6,5	47	25	6		
618-6	32	11	47	45	6		
617-8	16	6,5	47	25	8		
618-8	32	11	47	45	8		

Toebehoren:

Bestelnr.	Omschrijving	is voor:
KL10	Lager 9,5x3,7x3,2	

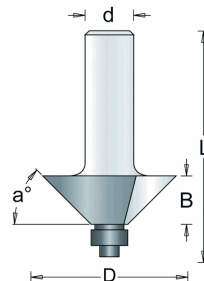

HM Amaxx Ogieffrees

Uitvoering: Met onderlager

Bestelnr.	D	B	L	R	d	P	U
619-6	25	15,8	50	4	6		
619-8	25	15,8	50	4	8		

Toebehoren:

Bestelnr.	Omschrijving	is voor:
KL10	Lager 9,5x3,7x3,2	

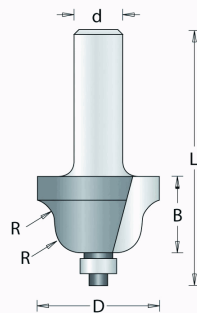
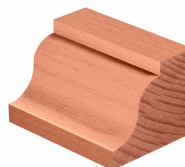

HM Amaxx Sponningfrees

Uitvoering: Met kogellager

Bestelnr.	D	B	L	d	P	U
620-6	28,6	9,5	46	6		
620-8	28,6	9,5	46	8		

Toebehoren:

Bestelnr.	Omschrijving	is voor:
KL10	Lager 9,5x3,7x3,2	

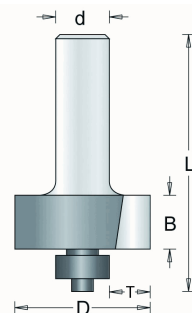
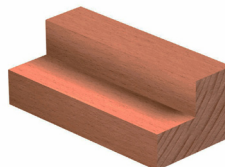

HM Amaxx Holprofiefrees

Uitvoering: Met onderlager

Bestelnr.	D	B	L	R	d	P	U
621-6	22	12,7	47	6,3	6		
622-6	28,6	14	48	9,5	6		
621-8	22	12,7	47	6,3	8		
622-8	28,6	14	48	9,5	8		

Toebehoren:

Bestelnr.	Omschrijving	is voor:
KL10	Lager 9,5x3,7x3,2	

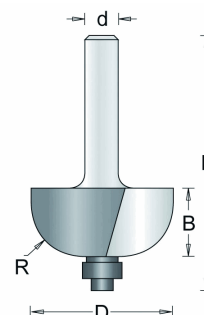
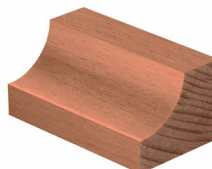

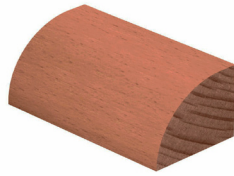
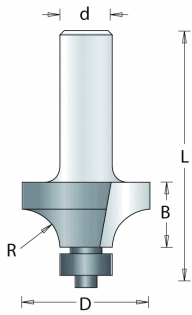

HM Amaxx Afrondingsfrees

Bestelnr.	Met onderlager				d	P	U
	D	B	L	R			
623-6	15,8	10,5	44	3,2	6		
624-6	22	13,5	46	6,3	6		
625-6	25	15,5	49	7,9	6		
626-6	28,6	17	50	9,5	6		
623-8	15,8	10,5	44	3,2	8		
624-8	22	13,5	46	6,3	8		
625-8	25	15,5	49	7,9	8		
626-8	28,6	17	50	9,5	8		

Toebehoren:

Bestelnr.	Omschrijving	is voor:
KL10	Lager 9,5x3,7x3,2	

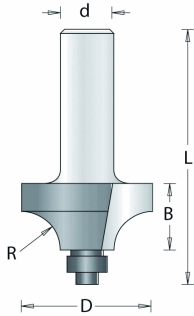

HM Amaxx Kwartrondfrees

Bestelnr.	(Duivejager) met onderlager				d	P	U
	D	B	L	R			
627-6	15,8	10,5	44	3,2	6		
628-6	22	13,5	46	6,3	6		
629-6	25	15,5	49	7,9	6		
630-6	28,6	17	50	9,5	6		
627-8	15,8	10,5	44	3,2	8		
628-8	22	13,5	46	6,3	8		
629-8	25	15,5	49	7,9	8		
630-8	28,6	17	50	9,5	8		

Toebehoren:

Bestelnr.	Omschrijving	is voor:
KL20	Lager 6,35x2,8x3,2	

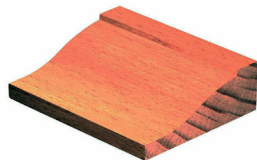
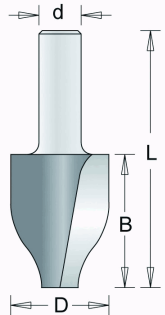

HM Amaxx Verticale Bossingfrees

Bestelnr.	Uitvoering:			d	P	U
	D	B	L			
647-6	41,2	41,2	79	6		

Amaxx wisselmessfreesen

HM Amaxx Groeffreesen met wisselmes

Toepassing: HM wisselmessen voor lange standtijd; Economisch gebruik door enkel wisselen van messen bij behoud van de frees; Nauwkeurig geslepen
Uitvoering: Voor intensief gebruik van sterk slijtende materialen zoals MDF

Bestelnr.	D	B	L	d	P	U
671-8	21	29,5	66	8		

Toebehoren:

Bestelnr.	Omschrijving	is voor:
680-1	HM wisselmes 29,5x9x1,5	
SC355	Boutje Torx M3x4	
SL200	Inbussleutel 1.9	

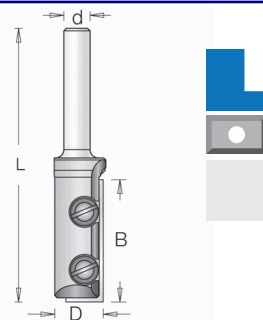

HM Amaxx Kantenfrees met kogellager en wisselmes

Toepassing: HM wisselmessen voor lange standtijd; Economisch gebruik door enkel wisselen van messen bij behoud van de frees; Nauwkeurig geslepen
Uitvoering: Voor intensief gebruik van sterk slijtende materialen zoals MDF

Bestelnr.	D	B	L	d	P	U
672-8	12,7	20	62	8		

Toebehoren:

Bestelnr.	Omschrijving	is voor:
680-2	HM wisselmes 20x9x1,5	
KL70	Lager 12,7x5x4,8	
SC355	Boutje Torx M3x4	
SL200	Inbussleutel 1.9	

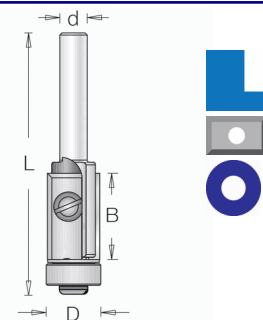
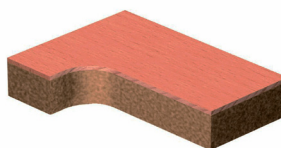

HM Amaxx Kantenfrees met kogellager en wisselmes

Toepassing: HM wisselmessen voor lange standtijd; Economisch gebruik door enkel wisselen van messen bij behoud van de frees; Nauwkeurig geslepen
Uitvoering: Voor intensief gebruik van sterk slijtende materialen zoals MDF

Bestelnr.	D	B	L	a	d	P	U
675-8	27,3	6,7	57	45	8		

Toebehoren:

Bestelnr.	Omschrijving	is voor:
680-5	HM wisselmes 12x12x1,5	
KL70	Lager 12,7x5x4,8	
SC355	Boutje Torx M3x4	
SL200	Inbussleutel 1.9	

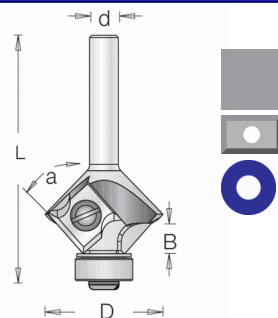
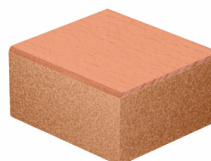

HM Amaxx Sponningfrees met kogellager en wisselmes

Toepassing: HM wisselmessen voor lange standtijd; Economisch gebruik door enkel wisselen van messen bij behoud van de frees; Nauwkeurig geslepen
Uitvoering: Voor intensief gebruik van sterk slijtende materialen zoals MDF

Bestelnr.	D	B	L	d	P	U
673-8	28,6	8,5	48	8		

Toebehoren:

Bestelnr.	Omschrijving	is voor:
680-3	HM wisselmes 13,25x9x1,1	
KL40	Lager 9,5x3,2x4,8	
SC355	Boutje Torx M3x4	
SL200	Inbussleutel 1.9	

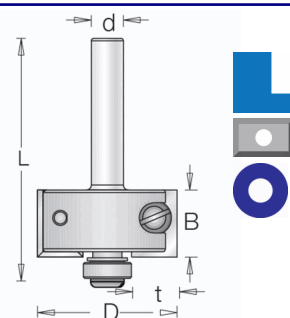
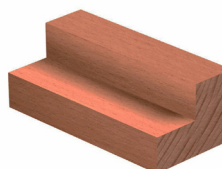

HM Amaxx Afrondingsfrees met kogellager en wisselmes

Toepassing: HM wisselmessen voor lange standtijd; Economisch gebruik door enkel wisselen van messen bij behoud van de frees; Nauwkeurig geslepen
Uitvoering: Voor intensief gebruik van sterk slijtende materialen zoals MDF

Bestelnr.	D	B	L	R	d	P	U
678-8	26	15,7	55	6	8		

Toebehoren:

Bestelnr.	Omschrijving	is voor:
680-8	HM wisselmes 15,7x9x1,5	
KL70	Lager 12,7x5x4,8	
SC355	Boutje Torx M3x4	
SL200	Inbussleutel 1.9	

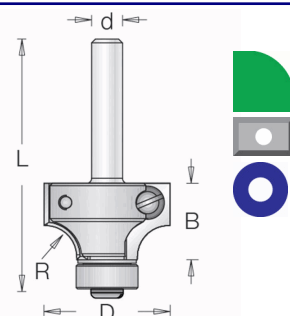

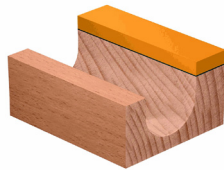
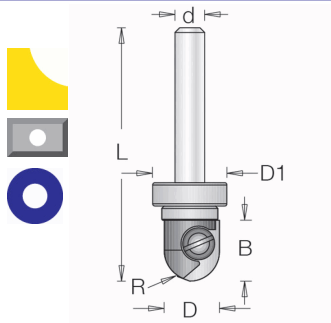

HM Amaxx Holprofielfrees met bovenlager en wisselmes

Toepassing: HM wisselmessen voor lange standtijd; Economisch gebruik door enkel wisselen van messen bij behoud van de frees; Nauwkeurig geslepen
Uitvoering: Voor intensief gebruik van sterk slijtende materialen zoals MDF

Bestelnr.	D	B	L	R	d	P	U
676-8	12,7	13	59	6	8		

Toebehoren:

Bestelnr.	Omschrijving	is voor:
680-6	HM wisselmes 13x9x1,5	
KL240	Lager 16x5x8	
SC355	Boutje Torx M3x4	
SL200	Inbusssleutel 1.9	

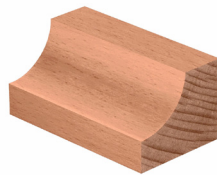
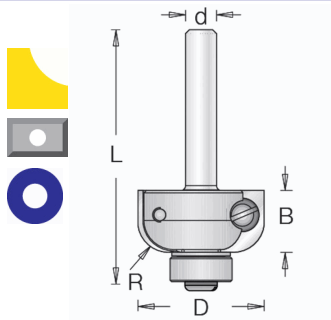

HM Amaxx Holprofielfrees met kogellager en wisselmes

Toepassing: HM wisselmessen voor lange standtijd; Economisch gebruik door enkel wisselen van messen bij behoud van de frees; Nauwkeurig geslepen
Uitvoering: Voor intensief gebruik van sterk slijtende materialen zoals MDF

Bestelnr.	D	B	L	R	d	P	U
677-8	26	12,7	52	6	8		

Toebehoren:

Bestelnr.	Omschrijving	is voor:
680-7	HM wisselmes 12,7x9x1,5	
KL30	Lager 12,7x4,8x6,35	
KL140/260	Lager 19x7x6,35	
LR110	Borgring 11x6,35x5	

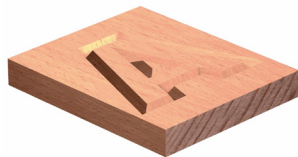
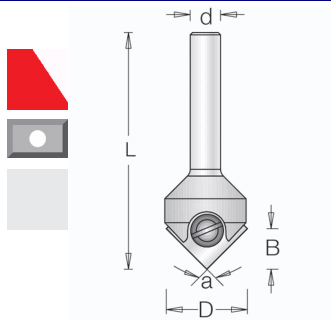

HM Amaxx V-groeffrees en wisselmes

Toepassing: HM wisselmessen voor lange standtijd; Economisch gebruik door enkel wisselen van messen bij behoud van de frees; Nauwkeurig geslepen
Uitvoering: Voor intensief gebruik van sterk slijtende materialen zoals MDF

Bestelnr.	D	B	L	a	d	P	U
674-8	17,6	8,5	53	45	8		

Toebehoren:

Bestelnr.	Omschrijving	is voor:
Wmes 680-4		
SC355	Boutje Torx M3x4	
SL200	Inbusssleutel 1.9	

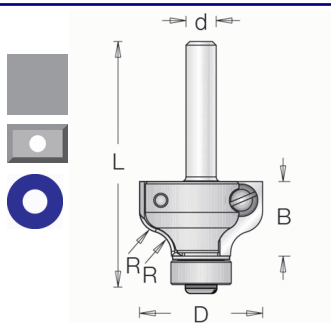

HM Amaxx Profielrees met onderlager en wisselmes

Toepassing: HM wisselmessen voor lange standtijd; Economisch gebruik door enkel wisselen van messen bij behoud van de frees; Nauwkeurig geslepen
Uitvoering: Voor intensief gebruik van sterk slijtende materialen zoals MDF

Bestelnr.	D	B	L	R	d	P	U
679-8	26	15,7	59	4,5	8		

Toebehoren:

Bestelnr.	Omschrijving	is voor:
680-9	HM Wisselmes 15,7x9x1,5	
KL70	Lager 12,7x5x4,8	
SC355	Boutje Torx M3x4	
SL200	Inbusssleutel 1.9	

Overige HSS frezen

HSS Groeffrees

Uitvoering: (Vingerfrees) Z=1

Bestelnr.	D	B	d	P	U
0-6	4	15	6		U
1-6	5	16	6		U
0-8	4	15	8		U

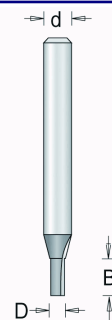
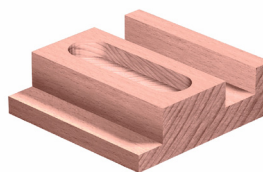

HSS Groeffrees

Uitvoering: (Vingerfrees) Z=2

Bestelnr.	D	B	d	P	U
3-6	8	19	6		U
4-6	10	19	6		U
5-6	12	19	6		U
7-6	20	16	6		U
122-8	6	20	8		U
123-8	8	20	8		U
125-8	12	20	8		U

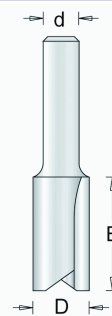

HSS Holprofielfrees

Uitvoering: Z=1

Bestelnr.	D	B	d	P	U
8-6	3,2	8	6		U
9-6	5	11	6		U
9-8	5	11	8		U

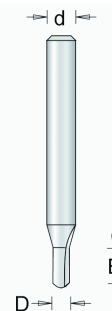
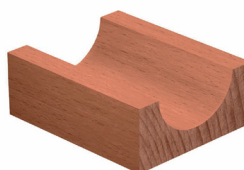

HSS Holprofielfrees

Uitvoering: Z=2

Bestelnr.	D	B	d	P	U
10-6	6,3	6,3	6		U
11-6	9,5	6,3	6		U
12-6	12,7	8,7	6		U
13-6	16	9,5	6		U
14-6	19	12	6		U
10-8	6,3	6,3	8		U
11-8	9,5	6,3	8		U
12-8	12,7	8,7	8		U
13-8	16	9,5	8		U
14-8	19	12	8		U

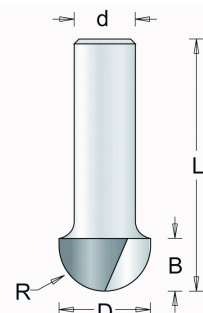
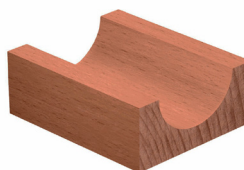

HSS V-groeffrees

Uitvoering: Z=2

Bestelnr.	D	B	a	d	P	U
15-6	13,5	9,5	45	6		U
16-6	31,3	22	45	6		U

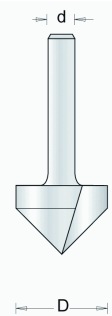
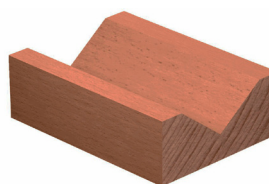

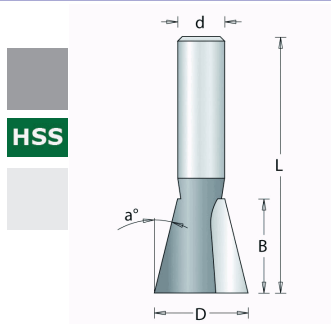

HSS Zwaluwstaartfrees

Uitvoering:		Z=2				
Bestelnr.	D	B		d	P	U
18-6	14,3	13,5		6		U
18-8	14,3	13,5		8		U

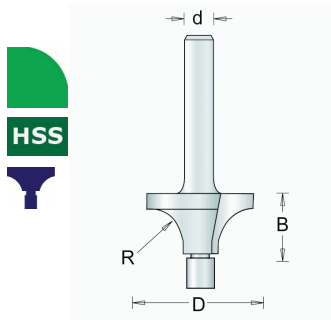

HSS Kwartrondfrees

Uitvoering:		(Duivejager) met aanlooptap Z=2				
Bestelnr.	D	B	R	d	P	U
24-6	14,4	9,5	3,2	6		U
25-6	20,6	12,7	6,3	6		U
26-6	27	19	9,5	6		U
24-8	14,4	9,5	3,2	8		U
25-8	20,6	12,7	6,3	8		U
26-8	27	19	9,5	8		U

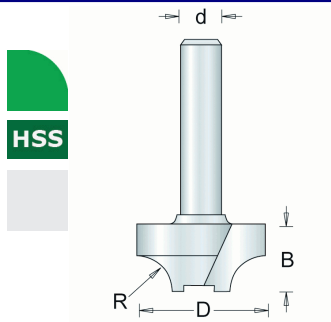

HSS Kwartrondfrees

Uitvoering:		Z=2				
Bestelnr.	D	B	R	d	P	U
132-8	17	12	5	8		U

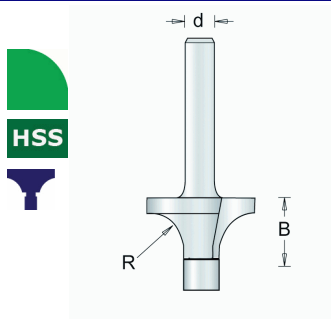

HSS Afrondfrees

Uitvoering:		met aanlooptap Z=2				
Bestelnr.	B	R	d	P	U	
19-6	9,5	5	6		U	
20-6	12,7	6,3	6		U	
21-6	12,7	8	6		U	
22-6	16	9,5	6		U	
19-8	9,5	5	8		U	
20-8	12,7	6,3	8		U	
21-8	12,7	8	8		U	
22-8	16	9,5	8		U	
23-8	20,6	13	8		U	

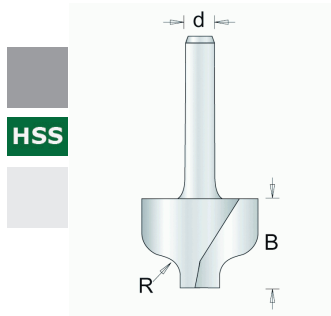

HSS Ogieffrees

Uitvoering:		Z=2				
Bestelnr.	B	R	d	P	U	
27-6	16	5	6		U	
28-6	23	7	6		U	
27-8	16	5	8		U	
28-8	23	7	8		U	

HSS Romeinse Ogieffrees

Uitvoering: met aanlooptap Z=2

Bestelnr.	B	R	d	P	U
29-6	12,7	4	6		U
30-6	19	6,3	6		U
29-8	12,7	4	8		U
30-8	19	6,3	8		U

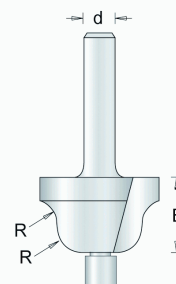

HSS Holprofielfrees

Uitvoering: met aanlooptap Z=2

Bestelnr.	B	R	d	P	U
31-6	12,7	6,3	6		U
32-6	19	9,5	6		U
33-6	19	12,7	6		U
31-8	12,7	6,3	8		U
32-8	19	9,5	8		U

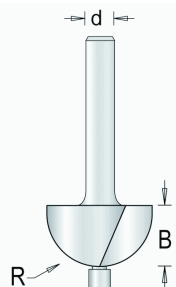

HSS Hoekfrees

Uitvoering: met aanlooptap 45° Z=2

Bestelnr.	D	B	d	P	U
34-6	27	16	6		U

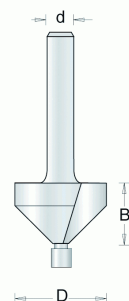
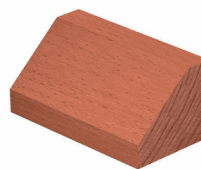

HSS Sponningfrees

Uitvoering: met aanlooptap Z=2

Bestelnr.	D	B	T	d	P	U
35-6	17,5	11,9	6,35	6		U
35-8	17,5	11,9	6,35	8		U
36-8	23,8	13,2	9,5	8		U

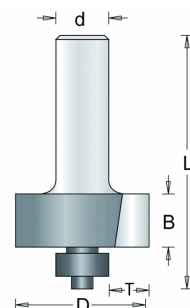
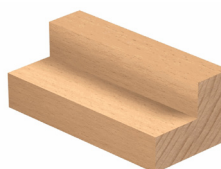

Frezensets

HM



Amaxx Set 6-delig

Toepassing: HM messen voor lange standtijd; Nauwkeurig geslepen en zilvergesoldeerd

Uitvoering: Kwaliteit voor de vakman en de veeleisende doe-het-zelver

Bestelnr.	D	B	L	a	R	R2	d	P	U
632-8SET							8		
Bevat:									
602-8	6	20	48				8		
605-8	12	20	48				8		
612-8	12,7	8	40	90			8		
614-8	12,7	8	40		6,3		8		
616-8	12,7	12,7	54				8		
626-8	28,6	17	50		9,5		8		

HM

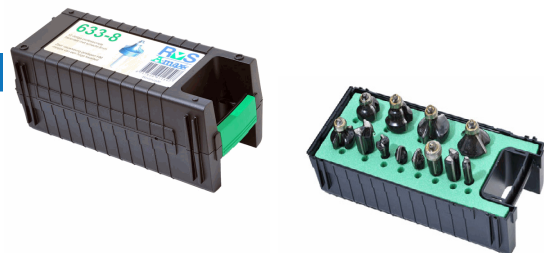

Amaxx Set 12-delig Basis 6mm

Toepassing: HM messen voor lange standtijd; Nauwkeurig geslepen en zilvergesoldeerd

Uitvoering: Kwaliteit voor de vakman en de veeleisende doe-het-zelver

Bestelnr.	D	B	L	a	R	R2	d	P	U
633-6SET							6		
Bevat:									
602-6	6	20	48				6		
605-6	12	20	48				6		
607-6	16	20	48				6		
610-6	12,7	12,7	45	14			6		
612-6	12,7	8	40	90			6		
614-6	12,7	8	40		6,3		6		
616-6	12,7	12,7	54				6		
618-6	32	11	47	45			6		
619-6	25	15,8	50		4		6		
621-6	22	12,7	47		6,3		6		
624-6	22	13,5	46		6,3		6		
626-6	28,6	17	50		9,5		6		

HM

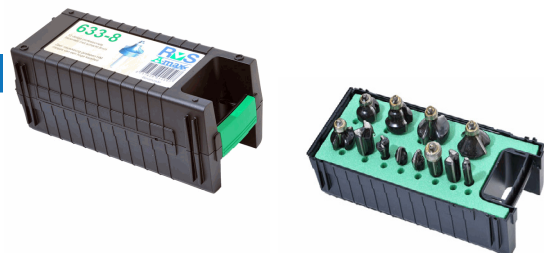

Amaxx Set 12-delig Basis 8mm

Toepassing: HM messen voor lange standtijd; Nauwkeurig geslepen en zilvergesoldeerd

Uitvoering: Kwaliteit voor de vakman en de veeleisende doe-het-zelver

Bestelnr.	D	B	L	a	R	R2	d	P	U
633-8SET							8		
Bevat:									
602-8	6	20	48				8		
605-8	12	20	48				8		
607-8	16	20	48				8		
610-8	12,7	12,7	45	14			8		
612-8	12,7	8	40	90			8		
614-8	12,7	8	40		6,3		8		
616-8	12,7	12,7	54				8		
618-8	32	11	47	45			8		
619-8	25	15,8	50		4		8		
621-8	22	12,7	47		6,3		8		
624-8	22	13,5	46		6,3		8		
626-8	28,6	17	50		9,5		8		

Amaxx Set 12-delig Uitbreiding 6mm

Toepassing: HM messen voor lange standtijd; Nauwkeurig geslepen en zilvergesoldeerd

Uitvoering: Kwaliteit voor de vakman en de veeleisende doe-het-zelver

Bestelnr.	D	B	L	a	R	R2	d	P	U
634-6SET							6		
Bevat:									
603-6	8	20	48				6		
604-6	10	20	48				6		
606-6	14	20	48				6		
609-6	20	20	48				6		
611-6	9,5	10	44	60			6		
613-6	6,3	5	40		3,2		6		
615-6	12,7	8	40		4	3,2	6		
617-6	16	6,5	47	25			6		
620-6	28,6	9,5	46				6		
622-6	28,6	14	48		9,5		6		
627-6	15,8	10,5	44		3,2		6		
628-8	22	13,5	46		6,3		8		



Amaxx Set 12-delig Uitbreiding 8mm

Toepassing: HM messen voor lange standtijd; Nauwkeurig geslepen en zilvergesoldeerd

Uitvoering: Kwaliteit voor de vakman en de veeleisende doe-het-zelver

Bestelnr.	D	B	L	a	R	R2	d	P	U
634-8SET							8		
Bevat:									
603-8	8	20	48				8		
604-8	10	20	48				8		
606-8	14	20	48				8		
609-8	20	20	48				8		
611-8	9,5	10	44	60			8		
613-8	6,3	5	40		3,2		8		
615-6	12,7	8	40		4	3,2	6		
617-6	16	6,5	47	25			6		
620-8	28,6	9,5	46				8		
622-6	28,6	14	48		9,5		6		
627-8	15,8	10,5	44		3,2		8		
629-6	25	15,5	49		7,9		6		



HM



Amaxx Set 30-delig (8mm)

Toepassing: HM messen voor lange standtijd; Nauwkeurig geslepen en zilvergesoldeerd

Uitvoering: Met 8mm schacht; Kwaliteit voor de vakman en de veeleisende doe-het-zelver

Bestelnr.	D	B	L	a	R	R2	d	P	U
635-8SET							8		
Bevat:									
601-8	5	12,7	48				8		
602-8	6	20	48				8		
603-8	8	20	48				8		
604-8	10	20	48				8		
605-8	12	20	48				8		
606-8	14	20	48				8		
607-8	16	20	48				8		
608-8	18	20	48				8		
609-8	20	20	48				8		
610-8	12,7	12,7	45	14			8		
611-8	9,5	10	44	60			8		
612-8	12,7	8	40	90			8		
613-8	6,3	5	40		3,2		8		
614-8	12,7	8	40		6,3		8		
615-8	12,7	8	40		4	3,2	8		
616-8	12,7	12,7	54				8		
617-8	16	6,5	47	25			8		
618-8	32	11	47	45			8		
619-8	25	15,8	50		4		8		
620-8	28,6	9,5	46				8		
621-8	22	12,7	47		6,3		8		
622-8	28,6	14	48		9,5		8		
623-8	15,8	10,5	44		3,2		8		
624-8	22	13,5	46		6,3		8		
625-8	25	15,5	49		7,9		8		
626-8	28,6	17	50		9,5		8		
627-8	15,8	10,5	44		3,2		8		
628-8	22	13,5	46		6,3		8		
629-8	25	15,5	49		7,9		8		
630-8	28,6	17	50		9,5		8		

Amaxx Set Wisselmessen

Toepassing: HM wisselmessen voor lange standtijd; Economisch gebruik door enkel wisselen van messen bij behoud van de frees; Nauwkeurig geslepen

Uitvoering: Voor intensief gebruik van sterk slijtende materialen zoals MDF

Bestelnr.	D	B	L	a	R	R2	d	P	U
670-8SET							8		
Bevat:									
672-8	12,7	20	62				8		
673-8	28,6	8,5	48				8		
674-8	17,6	8,5	53	45			8		
677-8	26	12,7	52		6		8		
678-8	26	15,7	55		6		8		
671-8	21	29,5	66				8		

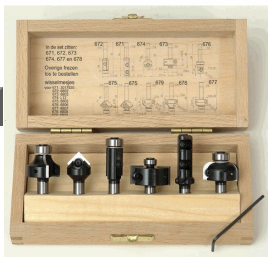

DHZ 12 delige freeset 6 of 8mm

Bestelnr.	d	P	U
SH06IT	6		
SH08IT	8		



HM

DHZ 12 delige freeset 8mm

Bestelnr.	d	P	U
EDH1000	8		



HM

DHZ 30-delige freeset 8mm

Bestelnr.	d	P	U
SH30IT	8		



HM

DHZ 4 delige freeset 12mm

Bestelnr.	d	P	U
SH12IT	8		



HM

DHZ 6-delige groeffrezenet 8mm

Bestelnr.	D	B	L	a	R	R2	d	P	U
EDH0600							8		



HM

DHZ 10 delige houtrot freeset 6mm

Bestelnr.	d	P	U
CH63-6XL	6		



HM

Frezen



DHZ Schijffreeset

Uitvoering:

Bestelnr.	B	L	a	R	R2	d	P	U
EDHSB-1						8		

Boren voor de bovenfrees

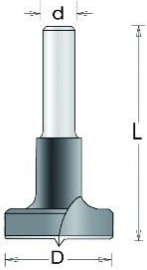

HM Boren

Uitvoering: Voor de bovenfrees met regelbaar toerental

Bestelnr.	D	L	d
B4620	20	55	8
B4625	25	55	8
B4626	26	55	8
B4630	30	55	8
B4635	35	55	8



HM Borensset 5-delig

Uitvoering: Voor de bovenfrees met regelbaar toerental
Bevat 20, 25, 26, 30 en 35 mm

Bestelnr.	D	L	d
B4600SET	55	8	

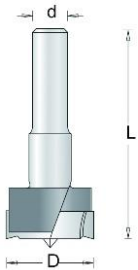

HM Boren

Uitvoering: Voor de bovenfrees

Bestelnr.	D	L	d
B698-8	25	60	8
B699-8	30	60	8
B701-8	34	60	8
B700-8	35	60	8
B702-8	40	60	8

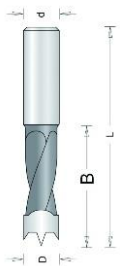

HM Drevelforen

Uitvoering: Voor de bovenfrees

Bestelnr.	D	B	L	d
B0570-8	5	35	70	8
B0670-8	6	43	70	8
B0870-8	8	43	70	8
B1070-8	10	43	70	8
B1270-8	12	43	70	8

Onderdelen en toebehoren

Spanbus

Bestelnr.	D	d	P	U
500	8	6		
501	12	8		
502	10	8		
503	8	6,35		
504	12	10		
505	12,7	8		
506	9,5	8		

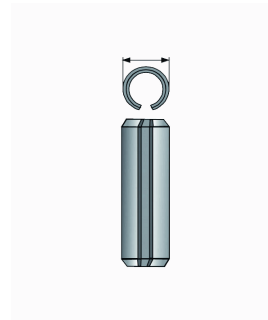

Spantang

Uitvoering: ELU, MOF96, MOF69, MKF67

Bestelnr.	d	P	U
510	6		
511	6,35		
512	8		

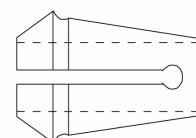

Spantang

Uitvoering: ELU, MOF177

Bestelnr.	d	P	U
520	6		
521	8		
522	12		

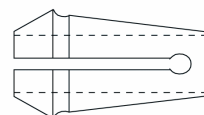

Spantang

Uitvoering: ELU, MOF31, M12x1 Binnendraad

Bestelnr.	d	P	U
530	6		
531	8		
532	12		

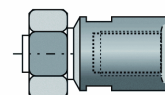

Spantang

Uitvoering: SCHEER, M10x1,5 Binnendraad

Bestelnr.	d	P	U
540	6		
541	8		

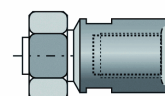

Frezen

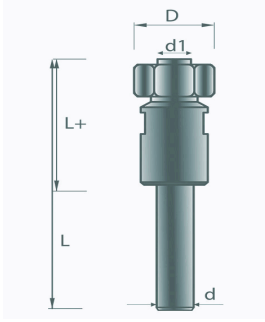

Verlengstukken

Uitvoering:

Bestelnr.	Dmin	Bmax	L	Dmax	d	P	U
556	20	25	40	35	8		
555	26	30	50	50	12		

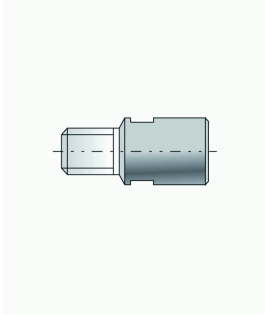

Verloopstift

Uitvoering:

M10x1,5 Binnendraad - M12x1 Buitendraad

Bestelnr.	P	U
551		

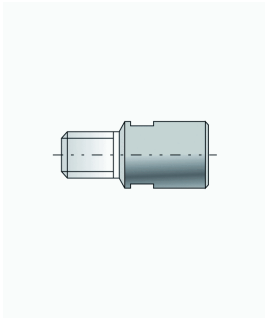

Verloopstift

Uitvoering:

M12 Binnendraad - M10 Buitendraad

Bestelnr.	P	U
552		

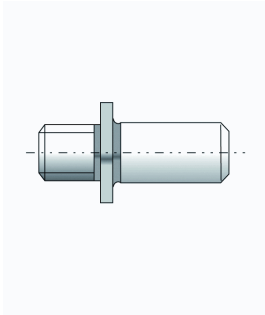

Verloopstift

Uitvoering:

M12x1

Bestelnr.	D	d	P	U
554	8	M12		
553	12	M12		

Kogellager

Bestelnr.	D	B	d	P	U
KLW48	4,8	2,4	2,4		
KL20	6,35	2,8	3,2		
KL10	9,5	3,7	3,2	9,55	
KL40	9,5	3,2	4,8		
KL70	12,7	5	4,8		
KL60	15,9	5	4,8		
KL150	19	5	4,8		
KL100	16	5	5		
KLW15	15	5	6		
KL110	22	7	6		
KLW22	22	7	6		
KL120	19	6	6		
KLW95	9,5	3,2	6,35		
KL30	12,7	4,8	6,35		
KL50/259	16	5	6,35		
KL140/260	19	7	6,35		
KL9720	25,4	9,1	6,35		
KLW12	12	3,5	8		
KL310	14	4	8		
KL240	16	5	8		
KL250	19	5	8		
KL130/116	22	7	8		
KL160	28	9	8		
KL9710	31,7	6,2	8		
KL9450	33,5	8,6	8		
KL170	26	8	10		
KL200	19	4	12,7		
KL180	28,6	7,9	12,7		
KL210	25,4	6	15		
KL9220	31,8	8,5	15		
KL190	35	11	15		
KL9221	38,1	9	15		
KL9210	25,4	6	12,7		

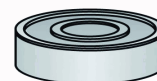

Delrin Kogellager

Lager met kunststof ring

Bestelnr.	D	B	a	d	P	U
KLD350	12,7	3,2		4,7		
KLD970	13,4	11,9		6,35		
KLD980	18,5	25,4		6,35		
KLD340	19	5		6,35		
KLD960	21,4	12,7		6,35		
KLD320	21,8	5	10	6,35		
KLD360	22,2	5	5	6,35		
KLD365	22,2	6,35	10	6,35		
KLD990	25,4	7	5	6,35		
KLD370	27	5		6,35		
KLD500	28	8,5		8		
KLD510	29	8,5		8		
KLD520	34	8,5		8		
KLD390	40,7	10,5		8		
KLD380	43	9,6		8		
KLD440	28,6	8,5		15		

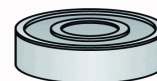

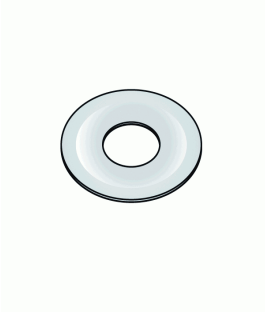

Ring

Uitvoering:

Bestelnr.	D	B	d	P	U
RB10	9,5		3,2		
RB50	12,7	5	6,35		
RB40	9,5		4,8		
RB70	12,7		6,35		
RB170	12,7	3	6,35		
RB100	16		5		
RB320	11	1,4	6,35		
RB270	9,5	2,2	6,35		
RB145	30	1	15		
RB1150					
RB1200					
RB180					
RBW48					

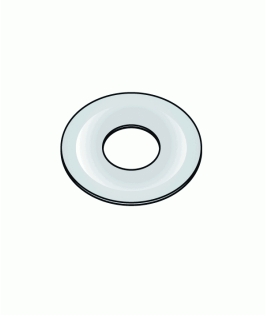

Vulring

Uitvoering:

Bestelnr.	D	B	d	P	U
RB500	16	0,05	8		
RB1000	16	0,1	8		
RB130	16	0,5	8		
RB110	16	1	8		
RB150	16	3	8		
RB290	16	5,3	8		
RB160	16	6	8		
RB9500	28	8,5	19,5		

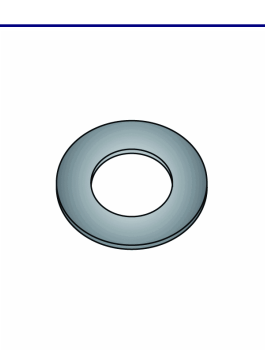

Ringen voor boutjes

Uitvoering:

Bestelnr.	d	P	U
SR40	2,4		
SR10	3,2		
SR800	4,8		

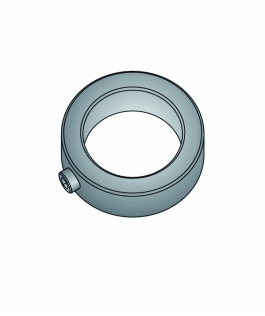

Borgring met inbus

Uitvoering:

Bestelnr.	D	B	d	P	U
LR230	16	5	8		
LR110	11	5	6,35		
LR160	16	5	9,5		
LR500	18,2	6	12,7		
LR200	20	6	12,7		

Sleutel:



Klemring

Uitvoering:

Bestelnr.	d	P	U
RR50	8		
RR60	15		

Inbusboutje

Bestelnr.	d	P	U
SC8070			
SC3850			
SC351			
SC250			
SC230	NC2		
SC220			
SC4045			
SC10	NC5 3/8		
SC16			
SC40	NC5-1/2		
SC70	NC3-3/8		
SC80	NF10-1/2		
SC85	NF10		
SC330	M3		
SC356			

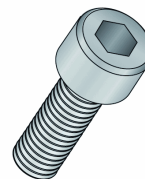

Stelboutje

Bestelnr.	L	d	P	U
SC211	2,5	NC5-40		
SC360	5	M3		

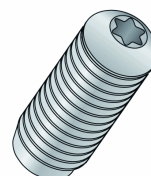

Torxboutje

Bestelnr.	L	d	P	U
SC1482	5,6	M4		
SC3548	4,8	M3,5		
SC1480	5	M4		
SC1481	5,6	M4		
SC3950	6	M4		
SC355	4	M3		
SC350	4	M3		
SC4040	6	M3,5		
SC770	12	M4		
SC4044	4	M2		
SC885	10	M4		



Boutje met kruiskop

Bestelnr.	d	P	U
SC20	NC2		

Inbussleutel

Bestelnr.	d	P	U
SL50	1,55		
SL10	2,4		
SL100	4		
SL200	1,9		
SL40	2		
SL45			
SL90	3		

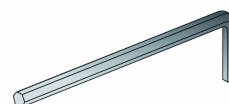

Torxsleutel

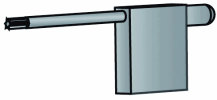

Uitvoering:

Bestelnr.	P	U
SLT9		
SLT10		
SLT15		
SLT20		

Wisselmessen

2-snedig; 1 gat

Bestelnr.	L	B	H
L76	7,5	12	1,5
L85	8,5	55	1,1
L96	9,6	12	1,1
L15	15	12	1,5
L20	20	12	1,5
L251	25	12	1,5



2-snedig; 2 gaten

Bestelnr.	L	B	H
L252	25	12	1,5
L30	30	12	1,5
L40	40	12	1,5
L50	50	12	1,5
L60	60	12	1,5
L80	80	13	2,2
L100	100	13	2,2
L120	120	13	2,2



4-snedig; 1 gat vierkant

Bestelnr.	L	B	H
LV75	7,5	12	1,5
LV12	12	12	1,5
LV141	14	14	1,2
LV142	14	14	2

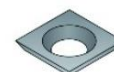

4-snedig; 1 gat

Bestelnr.	L	B	H
LV182	18	18	1,95
LV1825	18	18	2,5
LV183	18	18	3



4-snedig; 2 gaten

Bestelnr.	L	B	H
LV20	20	12	1,5
LV309	29,5	9	1,5
LV3012	29,5	12	1,5
LV502	49,5	12	1,5



4-snedig; 3 gaten

Bestelnr.	L	B	H
LV503	50	12	1,7



Wisselmessen voor kunststof:

4-snedig; 1 gat/2 gaten

Bestelnr.	L	B	H
LMG12	12	12	1,5
LMG50	50	12	1,5



Met borstgleuf; 2-snedig

Bestelnr.	L	B	H
LGF12	12	55	1,1
LGF20	20	55	1,1
LGF30	30	55	1,1
LGF40	40	55	1,1
LGF50	50	55	1,1



Met ruggleuf; 4-snedig

Bestelnr.	L	B	H
LKF20	20	55	1,1
LKF30	30	55	1,1
LKF50	50	55	1,1

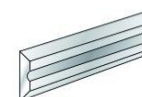

Index Frezencatalogus: Bestelnummer - Pagina

0-6	59	45-8	12	72-6	29	109	20	168-12	38
0-8	59	46-6	11	72-8	29	110	20	169-6	34
1-6	59	46-8	12	73-6	29	111	20	169-8	34
3-6	59	46-635	11	73-8	29	112	20	170-6	49
4-6	59	47-6	11	74-6	29	113	20	170-8	49
5-6	59	47-8	12	74-8	29	114-6	20	171-6	49
7-6	59	47-8-XL	12	75-6	29	115-8	20	171-8	49
8-6	59	48-6	11	75-8	29	115-12	20	172-6	49
9-6	59	48-635	11	76-6	30	117-12	39	172-8	49
9-8	59	48-8	12	76-8	30	118A-8	42	173-6	49
10-6	59	48-8-L	12	77-6	30	118A-12	42	173-8	49
10-8	59	49-6	11	77-8	30	118B-8	42	174-6	49
11-6	59	49-8	12	78-6	30	118B-12	42	174-8	49
11-8	59	49-8-XL	12	78-8	30	118C-8	42	175-6	49
12-6	59	50-6	11	79-6	30	118C-12	42	176-6	47
12-8	59	50-635	11	79-8	30	118D-8	43	176-8	47
13-6	59	50-8	12	80-6	30	118D-12	43	177-6	47
13-8	59	50-8-L	12	80-8	30	118E-8	43	177-8	47
14-6	59	51-6	11	81xs-6	46	118E-12	43	178-12	44
14-8	59	51-8	12	81-6	46	122-8	59	179-12	38
15-6	59	51-8-XL	12	81-8	46	123-8	59	180-6	35
16-6	59	52-6	11	82-6	46	125-8	59	180-8	35
18-6	60	52-635	11	82-8	46	128-12	34	182-6	33
18-8	60	52-8	12	83-6	30	129-12	34	182-8	33
19-6	60	52-8-L	12	83-8	30	130-8	12	183-12	33
19-8	60	52-8-XL	12	84-6	30	132-8	60	184-6	33
20-6	60	53-6	11	84-8	30	134xs-6	29	185-6	33
20-8	60	53-635	11	85-6	30	134-6	29	186-6	33
21-6	60	53-8	12	85-8	30	134-8	29	187-12	26
21-8	60	53-8-XL	12	86-6	30	135xs-6	29	188-6	28
22-6	60	54-6	11	86-8	30	135-6	29	188-8	28
22-8	60	54-8	12	86-12	30	135-635	29	189-6	22
23-8	60	54-8-XL	12	87-6	26	135-8	29	189-8	22
24-6	60	55-6	11	87-8	26	136-6	45	190-12	39
24-8	60	55-8	12	88xs-6	27	137-8	48	196-8	36
25-6	60	55-8-XL	12	88-6	27	139-6	35	198-8	36
25-8	60	56-6	11	88-8	27	140-6	35	199-6	36
26-6	60	56-8	12	89-6	46	140-8	35	199-8	36
26-8	60	56-8-XL	12	89-8	46	141-6	35	201-12	31
27-6	60	57-6	11	90-6	46	141-8	35	201-12ZL	31
27-8	60	57-8	12	91-6	46	142-6	35	202-8	32
28-6	60	57-8-XL	12	91-8	46	142-8	35	203-8	32
28-8	60	58-6	11	92-6	46	143-6	11	204-6	22
29-6	61	58-8	12	92-8	46	143-8	12	204-8	22
29-8	61	58-8-L	12	93-6	46	144-6	11	205-6	25
30-6	61	58-8-XL	12	93-8	46	144-8	12	205-8	25
30-8	61	59-6	11	94-6	47	145-6	37	206-6	26
31-6	61	59-8	12	94-8	47	145-8	37	206-8	26
31-8	61	60-6	33	95-6	47	146-6	37	207-8	24
32-6	61	60-8	33	95-8	47	146-8	37	208-8	24
32-8	61	61-6	33	96-6	48	147-6	37	208-12	13
33-6	61	61-8	33	97-6	48	147-8	37	209-8	24
34-6	61	62-6	33	97-8	48	148-6	37	210-8	24
35-6	61	62-8	33	98-6	36	148-8	37	210-10	13
35-8	61	63-6	33	98-8	36	149-8	12	210-12	13
36-8	61	63-6-XL	33	99-6	36	150-6	52	211-12	24
37-6	11	63-8	33	99-8	36	150-8	52	212-10	13
37-8	11	64-6	33	100-6	37	151-6	37	212-10-XL	13
38-6	11	64-8	33	100-8	37	151-8	37	212-12	13
38-8	11	65-6	33	101-6	37	152-6	27	212-12-XL	13
39-6	27	65-8	33	101-8	37	152-635	27	213-12	23
39-8	27	66-6	33	102-6	37	153-8	12	213-12DL	22
39-12	27	66-8	33	102-8	37	154-6	27	214-10	13
40-6	11	67-6	34	103xs-3,2	21	154-635	27	214-12	13
40-8	11	62-6	33	103xs-6	21	155-12	48	215-12	24
41-6	11	62-8	33	103-6	21	156-12	31	216-10	13
41-6-XL	11	67-8	34	103-8	21	157-8	52	216-10-L	13
41-8	11	68-6	34	104-6	22	160-6	31	216-10-XL	13
42-6	11	68-8	34	104-8	22	160-8	31	216-12	13
42-6-L	11	69-6	34	105xs-6	25	161-6	31	216-12-XL	13
42-8	11	69-8	34	105-6	25	161-8	31	217-8 VP	40
42-8-L	11	70-6	44	105-8	25	162-8	31	217-8 VR	40
43-6	11	70-8	44	106xs-6	25	163-6	38	217-8 VS	40
43-8	11	70-8-RXL	44	106-6	25	164-6	38	218-10	13
44-6	11	71xs-6	29	106-8	25	165-12	38	218-10-XL	13
44-8	12	71-6	29	107	20	166-12	38	218-12	13
45-6	11	71-8	29	108	20	167-12	38	218-12-XL	13

Index Frezencatalogus: Bestelnummer - Pagina

220-10	13	285-12	29	355-6	12	441-8	17	628-6	56
220-12	13	286-12	30	355-8	12	442-12	17	628-8	56
220-12-XL	13	287-12	44	355-8XXL	13	445-6	23	629-6	56
221-8	20	288-12	28	356-12	19	450-8	16	629-8	56
222-10	13	289-8	40	357-12	19	450-8-XL	16	630-6	56
222-12	13	289-12	40	358-12	19	450-8-XXL	16	630-8	56
223-8	35	290-12	39	359-12	19	450-12	16	632-8SET	62
224-8	35	291-12	52	360-12	19	450-12-XXL	16	633-6SET	62
225-10	13	292-12	53	361-8	19	451-12	16	633-8SET	62
225-12	13	293-6	52	363	19	452-12	16	634-6SET	63
226-8	32	294-6	52	364	19	453-8	16	634-8SET	63
227-8	32	295-8	26	365	19	453-12	16	635-8SET	64
228-8	32	296-8	44	366	19	454-12	17	647-6	56
229-6	32	297-8	44	375-12	50	455-12	16	670-8SET	64
230-12	13	297-12	44	376-8	30	456-12	17	671-8	57
231-6	21	298-12	44	376-12	30	457-12	16	672-8	57
232-12	31	299-12	48	377-12	30	458-12	17	673-8	57
233-6	21	S303-8	17	378-12	30	459-12	16	674-8	58
234-6	42	S304-8	17	379-12	30	460-12	17	675-8	57
234A-6	42	S305-8	17	380-12	30	461-12	16	676-8	58
234B-6	42	S306-8	17	381-12	30	471-12	13	677-8	58
235-12	13	S308-8	17	382-12	30	472-12	13	678-8	57
236-6	13	300-8	34	383-12	29	490-8	26	679-8	58
237-8	21	301-6	47	384-12	30	601-6	54	701-8	17
238-12	21	301-8	47	385-12	30	601-8	54	702-10	17
239-12	21	302-6	47	386-12	30	602-6	54	703-12	17
240-12	13	302-8	47	383-12	29	602-8	54	1010N	14
241-12	23	303-6	47	388-12	28	603-6	54	1012N	14
242-12	23	303-8	47	390-12	50	603-8	54	1014N	14
243-12	23	305-8	34	391-12	51	604-6	54	1016N	14
244-6	34	306-8	36	392-12	51	604-8	54	1018N	14
245xs-6	25	307-8	36	393-12	50	605-6	54	1020N	14
245-6	25	308-8	36	394-12	51	605-8	54	1022N	14
246-8	43	309-8	36	395-12	51	606-6	54	1024N	14
246-12	43	310-8	36	396-12	50	606-8	54	1025N	14
247-3.2	25	311-8	36	397-12	50	607-6	54	1030N	14
247-6	25	312-8	36	398-12	50	607-8	54	1210M	14
248-12	21	313-8	36	399-12	50	608-6	54	1212M	14
249-8	25	314-8	33	400-8	20	608-8	54	1214M	14
250	19	315-8	36	401-8	20	609-6	54	1216M	14
251	19	316-8	36	401-12	20	609-8	54	1218M	14
252	19	317-12	39	402-8	20	610-6	54	1218WM	14
253	19	318-12	39	402-12	20	610-8	54	1220M	14
254	19	320-8	35	403-8	22	611-6	54	1222M	14
255	19	311-8	36	404-6	22	611-8	54	1225M	14
256	19	312-8	36	404-8	22	612-6	54	1230M	14
257-6	19	313-8	36	404-12	22	612-8	54	1234M	14
258-8	19	314-8	33	405-6	25	613-6	54	1235M	14
260-8	25	315-8	36	405-8	25	613-8	54	321M6	14
261-12	31	316-8	36	406-6	25	614-6	54	322M6	14
262-8	33	317-12	39	407-6	23	614-8	54	323M6	14
262-12	33	318-12	39	407-8	23	615-6	55	324M6	14
263-8	33	320-8	35	410-8	14	615-8	55	3212-12	12
263-12	33	320-8SET	35	411-6	14	616-6	55	3216-12	12
264-12	33	337-8	17	411-8	14	616-8	55	3220-12	12
265-12	33	338-8	17	412-6	14	617-6	55	6000-12	44
266-12	33	339-8	17	420-8	15	617-8	55	60312	18
267-12	34	340-8	17	420-12	15	618-6	55	60412	18
268-12	34	342-8	17	421-6	15	618-8	55	60445	18
269-12	34	346-6	12	421-8	15	619-6	55	60512	18
270-12	40	346-8	12	421-8-XL	15	619-8	55	60518	18
271-12	41	348-6	12	422-6	15	620-6	55	60614	18
272-12	41	348-8	12	422-8	15	620-8	55	60814	18
273-12	39	348-8XXL	13	422-12	15	621-6	55	61014	18
274-6	32	350-6	12	430-12	15	621-8	55	61214	18
275-8	31	350-8	12	432-8	15	622-6	55	61518	18
276-8	29	351-8	12	432-12	15	622-8	55	SH06IT	65
276-12	29	351-8XXL	13	434-8	15	623-6	56	SH08IT	65
277-12	29	352-6	12	434-12	15	623-8	56	EDH1000	65
278-12	29	352-8	12	436-8	15	624-6	56	SH30IT	65
279-12	29	352-8XXL	13	436-12	15	624-8	56	SH12IT	65
280-8	22	353-6	12	438-12	15	625-6	56	EDH0600	65
280-12	29	353-8	12	440-12	15	625-8	56	CH63-6XL	65
281-12	29	353-8XXL	13	433-12	15	626-6	56	EDHSB-1	66
282-12	29	354-6	12	435-12	15	626-8	56	Onderdelen	67
283-12	29	354-8	12	437-12	15	627-6	56	&	-
284-12	29	354-8XXL	13	439-12	15	627-8	56	toebehoren	73



RvS Tools
Meridiaan 53
2801 DA Gouda
T: 0182 338444
F: 0182 551250

info@rvsnl.com
www.rvstools.nl

